



WebdynSun

User Manual

Index

1. Glossary.....	7
2. About this Document.....	8
2.1 Scope.....	8
2.2 Target Audience.....	8
2.3 Product Versions.....	8
2.4 Safety Advice.....	8
3. Principles of Operation.....	10
3.1 Overview Diagram of a Comprehensive Monitoring Solution.....	10
4. Unit Characteristics.....	11
4.1 Technical Characteristics.....	11
4.2 List of Available Interfaces.....	12
4.3 Options and Accessories.....	13
4.3.1 DIN Rail Power Supply.....	13
4.3.2 GSM/GPRS Right-Angled Stub Antenna.....	20
4.3.3 GSM/GPRS Externally Mounted Antenna.....	20
5. Prerequisites.....	21
5.1 Access to the FTP Server.....	21
5.2 Access to the NTP Server.....	22
5.3 Connection via GPRS or Ethernet.....	22
5.3.1 Ethernet Connection.....	22
5.3.2 GPRS Connection.....	22
5.3.3 Managing the PIN Code for the SIM Card.....	22
6. Configuring the Unit.....	24
6.1 Roles of the WebdynSun Files.....	24
6.1.1 Configuration Files.....	24
6.1.2 Definition Files.....	24
6.2 Initialization.....	25
6.2.1 Configuration via the Built-In Web Server.....	28
6.2.2 Configuration via SMS.....	34
6.3 Setting the Unit Date and Time.....	35

6.4 Connection Modes and Periods.....	36
6.4.1 Manual Connection.....	36
6.4.2 Periodic Automatic Connection.....	37
6.4.3 Automatic Connection at Fixed Times.....	38
6.4.4 Automatic Connection on Data Capture.....	39
6.4.5 Keeping the Connection Open.....	40
6.4.6 Automatic Connection on Alarm.....	40
6.4.7 Optimising the Connection.....	41
6.5 Acquisition Period and Time Slots.....	42
7. Inverter Management.....	43
7.1 Inverter Wiring.....	43
7.2 Inverter Discovery.....	45
7.2.1 Discovering Inverters Using the Built-In Web Server.....	45
7.2.2 Discovering Inverters via a Command File.....	46
7.3 Declaring and Configuring Inverters.....	48
7.4 Inverter Definition Files.....	50
7.5 Checking that Inverters are Operating Correctly.....	51
7.6 Inverter Data.....	52
7.6.1 Filename Syntax.....	52
7.6.2 Format of Inverter Data.....	53
7.6.3 Example.....	54
7.7 Inverter Parameters.....	56
7.8 Inverter Alarms.....	57
7.8.1 Filename Syntax.....	57
7.8.2 Format of Alarms.....	57
7.8.3 Example of Alarm File.....	58
8. TIC (Smart) Meter Management.....	59
8.1 Smart Meter Wiring.....	59
8.2 Smart Meter Discovery.....	61
8.2.1 Discovering Meters Using the Built-In Web Server.....	61
8.2.2 Discovering Meters via a Command File.....	62
8.3 Declaring Meters.....	63

8.4 Meter Definition Files.....	64	10.5.2 Data Format.....	97
8.5 Checking that Meters are Operating Correctly	67	10.5.3 Example	99
8.6 Meter Data.....	67	10.6 Modbus Alarms	102
8.6.1 Filename Syntax	68	10.6.1 Alarm Filename Syntax	102
8.6.2 Format of Meter Data.....	68	10.6.2 Format of Alarms.....	103
8.6.3 Example.....	69	10.6.3 Example of Alarm File	103
9. Input/Output Management.....	72	10.7 Writing Modbus Variables via a Command File	105
9.1 Wiring.....	72	11. Displaying Operating Data	106
9.1.1 Analogue Inputs (0–10 V or 4–20 mA)	72	11.1 Displaying Cumulative Variables	106
9.1.2 Switching Relay Outputs.....	73	11.2 Displaying Instantaneous Variables	109
9.1.3 Dry Contact Inputs.....	74	11.3 Details of the Definition File IDsite_REPORT.ini.....	109
9.1.4 Index Inputs: Pulse Counting	75	11.3.1 Default Definition File IDsite_REPORT.ini	111
9.2 Declaring Input/Output Ports	75	11.3.2 Examples of IDsite_REPORT.ini Configuration.....	111
9.3 Input/Output Definition Files.....	76	11.3.3 Configuring a Siebert Modbus Display.....	111
9.4 Checking that Input/Output Ports are Operating Correctly	78	12. Command File.....	114
9.5 Input/Output Data.....	79	12.1 GATEWAY Type Commands.....	115
9.5.1 Filename Syntax	79	12.2 I/O Type Commands	115
9.5.2 Format of	79	12.3 MODBUS Type Commands	115
9.5.3 input/Output Data	79	13. Updating the Unit.....	116
9.5.4 Example:.....	81	13.1 Updating via the Web Server.....	116
9.6 Alarms on the Dry Loop Inputs.....	83	13.2 Updating Remotely via the FTP Server	117
9.6.1 Syntax of the Alarms File Name.....	83	14. Using Web Services	118
9.6.2 Format of Alarms	83	14.1 Enabling and Configuring	118
9.6.3 Example of an Alarm on a Dry Loop.....	84	14.2 Format of HTTP Requests.....	118
9.7 Controlling Relays via a Command File	85	14.3 Examples of Web Services Requests	121
10. Modbus Device Management.....	86	15. Tools and Diagnostics	122
10.1 Bus Wiring	86	15.1 Events Journal	122
10.2 Configuring and Declaring Modbus Slave Sevicees	88	15.2 Modem Information	125
10.3 Structure of a Modbus Definition File.....	91	15.3 Detecting Power Connection	126
10.4 Checking that Modbus Devices are Operating Correctly.....	96	15.3.1 Syntax of the Alarm File Name:	126
10.5 Modbus Data.....	96	15.3.2 Format of Alarms.....	126
10.5.1 Filename Syntax	96	15.4 LED Indicators	127

15.5 Installation Button	129
15.6 Diagnostic SMSs	129
15.7 Debug Traces	131
15.8 Factory Reset Procedure	132
Sales Contact	133

1. Glossary

NAME	DESCRIPTION
APN	Access Point Name: name of the access point that enables the gateway to connect to the Internet via a mobile link.
ERDF	Électricité Réseau Distribution France, the French National Grid, which defines connection norms for installations and meters, especially smart meters. See TIC.
FTP	File Transfer Protocol: communications protocol used to share data files on a TCP/IP network.
GPRS	General Packet Radio Service: standard for mobile telephone communications derived from the GSM standard and enabling higher data transfer rates. Also known as 2.5G. DL: maximum 86 kbps; UL: maximum 43 kbps.
GSM	Global System for Mobile Communications: the switched network for mobile telephones.
HTTP	HyperText Transfer Protocol: client-server communications protocol developed for the Web.
IP	Internet Protocol: message protocol controlling the addressing and transmission of TCP packets over the network.
DIN Rail	Standardised 35-mm metal rail used in Europe for rack-mounted industrial control equipment.
PSTN	Public switched telephone network: switched network for telephone land lines.
TCP	Transmission Control Protocol: a connection-oriented protocol for the Internet, which provides data segmentation into packets that are transmitted over the network via the IP protocol. This protocol provides a reliable data transfer service. See also IP.
TCP/IP	Transmission Control Protocol/Internet Protocol: the suite of network protocols that provide interconnection services between computers with different hardware architectures and operating systems. TCP/IP includes standards for communication between computers and conventions for network interconnection and for routing.
TIC	“Télé-Information Client [Remote Customer Information]”: digital data output port for ERDF smart meters, which provides constant output of the contractual parameters managed, as well as the consumption figures measured by the unit.

2. About this Document

The purpose of this guide is to describe the installation and operation of a WebdynSun gateway.

For all instructions pertaining to the installation and operation of inverters, please see the Appendices corresponding to the individual inverters.

2.1 Scope

The present technical description is valid for WebdynSun gateways from hardware version 2 onwards, and from software version V3.02.21 and up.

2.2 Target Audience

This guide is intended for users of WebdynSun gateways.

2.3 Product Versions

There are two versions of this unit:

VERSION	PRODUCT
V1	WGE-G-PV: this model includes a GSM/GPRS modem.
V2	WGE-R-PV: this model includes a PSTN/PSTN modem.

This manual covers only the WGE-G-PV variant. For all specific details concerning the WGE-R-PV variant, please contact WebdynSun support.

2.4 Safety Advice

It is essential to respect all safety recommendations featured in this guide.

Failure to comply with these recommendations may cause damage to equipment and danger to the health safety of personnel.



Electrical connections:

- All wiring must be carried out only by a specialised qualified electrician.
- Prior to installation, all equipment connected to the corresponding communications bus must be disconnected on both sides (DC and AC).
- Respect all safety recommendations appearing in inverter documentation.



The WebdynSun unit is liable to damage from electrostatic discharge (ESD). Avoid all contact with component connectors and terminals



The WebdynSun unit contains a lithium battery

WARNING: RISK OF EXPLOSION IF THE BATTERY IS REPLACED BY ANOTHER BATTERY OF AN INCORRECT TYPE. DISCARD ALL WORN-OUT BATTERIES IN COMPLIANCE WITH THEIR INSTRUCTIONS.

3. Principles of Operation

The WebdynSun gateway is the communications hub for your solar generator. It continuously collects all the data from inverters, sensors, electric meters and Modbus units. In this way, it enables you to be informed constantly on the operational state of your installation.

3.1 Overview Diagram of a Comprehensive Monitoring Solution

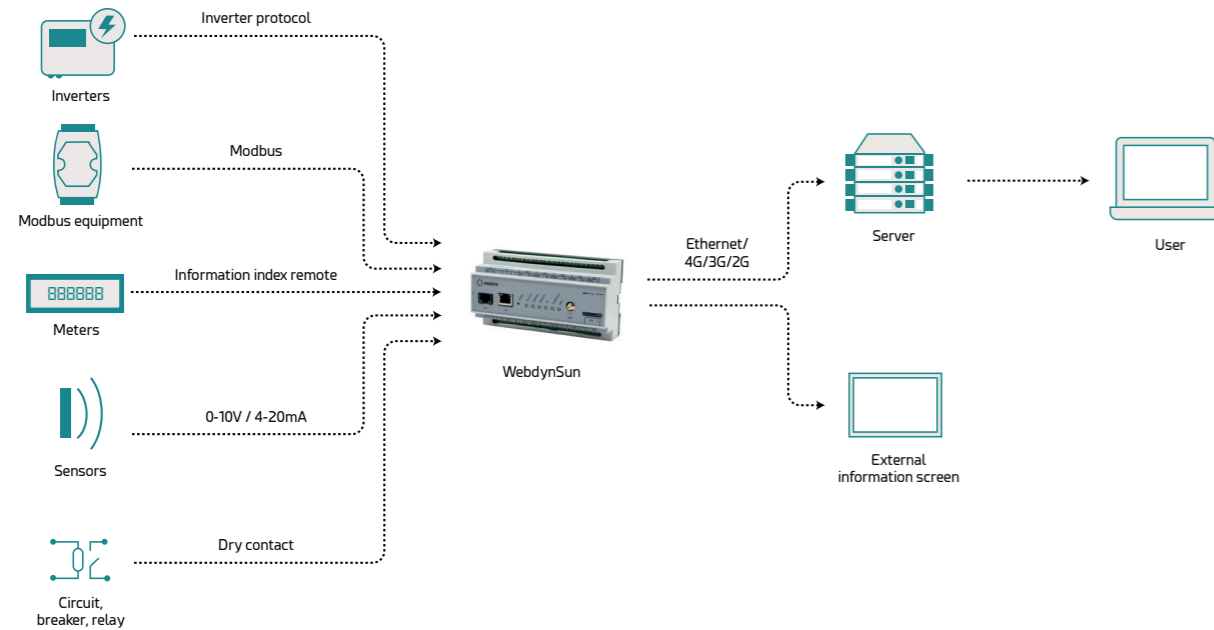

4. Unit Characteristics

4.1 Technical Characteristics

ELECTRICAL CHARACTERISTICS	
Input tension	12 / 24 V
Electricity consumption when idle	2.8 W (1)
Electricity consumption when connected via Ethernet	3.2 W (1)
Maximum peak power during GPRS connection	5 W (1)
Lithium-Ion battery	3.7V-650mA-2.4Wh
GSM/GPRS antenna: Microel EA-247	
Frequency	900/1800 MHz
Gain	0 dB
Polarisation	Vertical
Memory	
Storage capacity	100 MB of compressed data
Dimensions	
Size	157x86x58.5 mm
DIN Rail Unity	9 modules
ENVIRONMENTAL CONDITIONS	
Size	157x86x58.5 mm
DIN Rail Unity	9 modules
Size	157x86x58.5 mm

(1) Measurements carried out on the Unit + DIN Rail DR15-24 power supply assembly.

4.2 List of Available Interfaces

DATA SOURCE	INTERFACE	CHARACTERISTICS
Inverters	RS485 (A) 2/4-wire, Ethernet	Maximum number depends on the brand (1)
Electric meters (ERDF : Bleu, jaune, émeraude, PME-PMI)	Remote customer information (TIC)	3 max
Modbus devices	RS485 2/4-wire	247 max
Analogue sensors: (temperature, light level, etc.).	0-10V or 4-20mA 2 wires + power	4 max. 10bits resolution
Status sensors (open/closed)	Dry contact via 2 wires	4 max
Indicator lamp	Switching relay via 2 wires	2 max
Pulse counter, safety switch	Dry contact via 2 wires	2 max

(1) For the maximum number of inverters that the gateway can handle, please see the Appendix that corresponds to their brand: Appendix-Brand-WebdynSun.pdf.

COMMUNICATIONS CHANNEL	PROTOCOL
Ethernet 10/100 Mbps	IP Services
GSM/GPRS Modem (WGE-G-PV)	IP Services
REMOTE SERVERS	PROTOCOL
FTP server	FTP
HTTP server (Web Services option)	HTTP
NTP server	NTP

4.3 Options and Accessories

4.3.1 DIN Rail Power Supply

Brand: MEANWELL; reference No.: DR-15-24

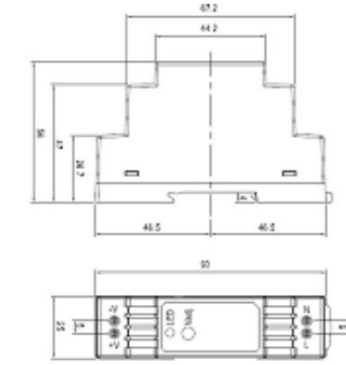

This power supply unit is mounted next to the gateway on the standard 35-mm DIN RAIL metal rail. This rail mounting means that no other mounting bracket is required.



- If the DIN RAIL unit is used to supply power remotely to analogue modules, please check the output tension adjustment value.
- In addition, check the power consumption of all remotely powered modules.

Characteristics:

OUTPUT	DC VOLTAGE	24V	
	RATED CURRENT	0.63A	
	CURRENT RANGE	0 ~ 0.63A	
	RATED POWER	15.2W	
	RIPPLE & NOISE (max.) Note.2	150mVp-p	
	VOLTAGE ADJ. RANGE	21.6 ~ 26.4V	
	VOLTAGE TOLERANCE Note.3	±1.0%	
	LINE REGULATION	±1.0%	
	LOAD REGULATION	±1.0%	
	SETUP, RISE TIME	1000ms, 50ms/230VAC; 1000ms, 50ms/115VAC at full load	
	HOLD UP TIME (Typ.)	70ms/230VAC; 16ms/115VAC at full load	
INPUT	VOLTAGE RANGE	85 ~ 264VAC	120 ~ 370VDC
	FREQUENCY RANGE	47 ~ 63Hz	
	EFFICIENCY (Typ.)	85%	
	AC CURRENT (Typ.)	0.88A/115VAC; 0.48A/230VAC	
	INRUSH CURRENT (Typ.)	COLD START 35A/115VAC; 65A/230VAC	

PROTECTION	OVERLOAD Note.5	105 ~ 160% rated output power; Protection type: Constant current limiting, recovers automatically after fault condition is removed	
	OVER VOLTAGE	27.6 ~ 32.4V	
ENVIRONMENT	WORKING TEMP.	-20 °C ~ +60 °C (Refer to output load derating curve)	
	WORKING HUMIDITY	20 ~ 90% RH non-condensing	
	STORAGE TEMP., HUMIDITY	-40 °C ~ +85 °C, 10 ~ 95% RH	
	TEMP. COEFFICIENT	±0.03%/ (0 ~ 50) °C	
SAFETY & EMC	VIBRATION	10 ~ 500Hz, 2G 10min./1cycle, period for 60min. each along X, Y, Z axes; Mounting: Compliance to IEC60068-2-6	
	SAFETY STANDARDS	UL60950-1, TUV EN60950-1 approved, design refer to EN50178	
	WITHSTAND VOLTAGE	I/P-O/P: 3 KV AC	
	ISOLATION RESISTANCE	I/P-O/P: 100 megohm / 500 V DC / 25 / 70% RH	
	EMI CONDUCTION & RADIATION	Compliance to EN55011, EN55022 (CISPR22), EN61204-3 Class B	
OTHERS	HARMONIC CURRENT	Compliance to EN61000-3-2, -3	
	EMS IMMUNITY	Compliance to EN61000-4-2, 3, 4, 5, 6, 8, 11, ENV50204, EN55024, EN61000-6-2, EN61204-3, heavy industry level, criteria A	
	MTBF	1172.3K hr min.	MIL-HDBK-217F (25)
	DIMENSION	25*93*56mm (W*H*D)	

4.3.2 GSM/GPRS Right-Angled Stub Antenna

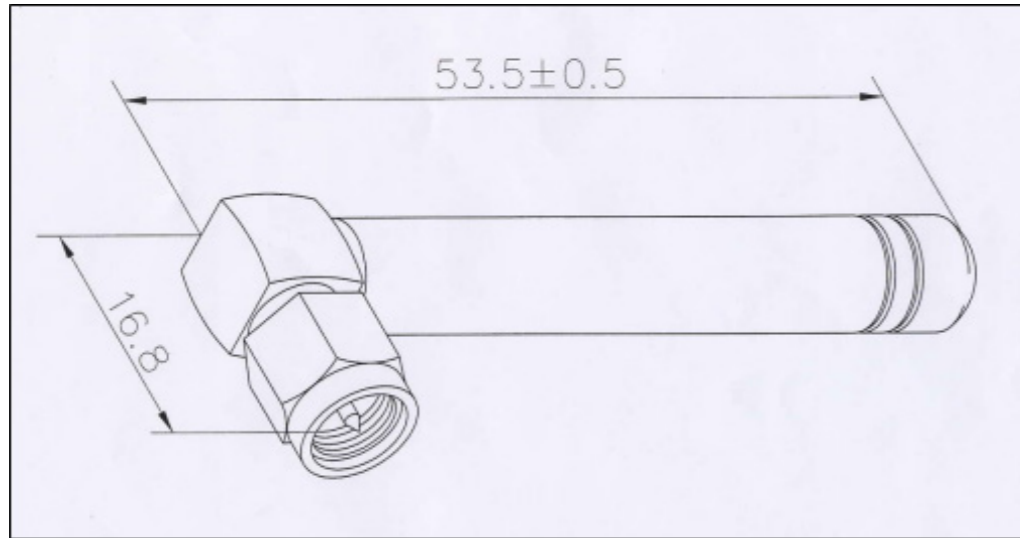

Characteristics:

Frequency range	900-1800 MHz
-----------------	--------------

4.3.3 GSM/GPRS Externally Mounted Antenna

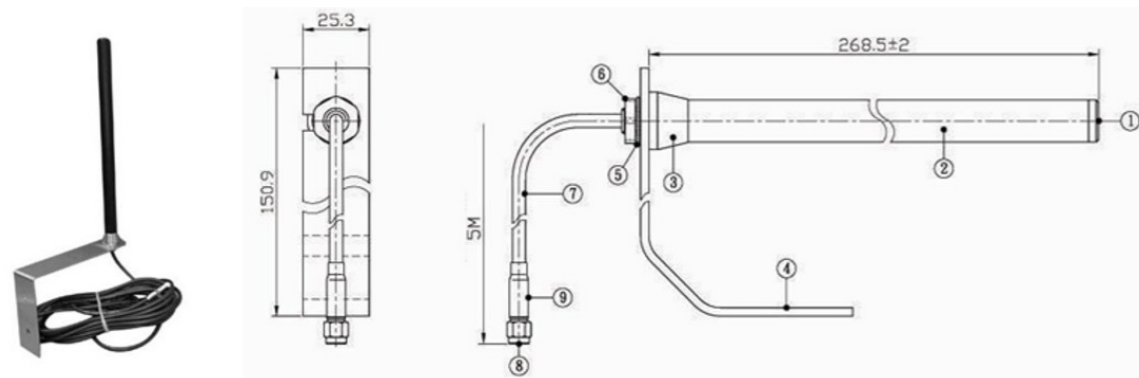

Characteristics:

Cable:	RG-58
Cable length:	5,10 or 20 meters available
Frequency ranges	824-960 MHz; 1710-1990 MHz
Options	Mounting bracket

5. Prerequisites

Configuration of the WebdynSun is mainly carried out using configuration and definition files, which are available on a remote FTP server. Consequently, it is vitally important that the WebdynSun gateway should have access to an FTP server for downloading and/or uploading its configuration and definition files, as well as its data, alarm and log files.

In addition, the factory default time and date setting of the gateway is 1st January 1970 at 00:00. Time synchronisation is therefore required to enable the data to be correctly timestamped. For this purpose, the gateway must synchronise itself with an NTP (Network Time Protocol) server.

For these reasons, it is important to ensure that the prerequisites listed below are correctly entered.

5.1 Access to the FTP Server

For the configuration of the remote FTP server, it is essential to respect the following configuration:

- Read/Write/Rename access authorised.
- Passive mode enabled.
- Port 21 (by default).
- Short handshake message.
- Login and Password must be less than 30 characters.

As the WebdynSun gateway does not create any directories, the FTP server must provide the directories and subdirectories for configuration, definition, data, alarms, commands, logs and updates. Here is a list of the default directories expected:

- /CONFIG: Contains the configuration files for the gateway.
- /DEF: Contains the definition files for the modules and sensors to be controlled:
 - /INV: Definition files for inverters.
 - /TIC: Definition files for electric meters.
 - /IO: Definition files for analogue and digital input/output, and index entries.
 - /MODBUS: Definition files for Modbus units.
 - /REPORT: Definition files for variables to be displayed on the home page or on a display panel.
- /BIN: contains the binary files of the gateway for update purposes.
- /DATA: Directory for upload of data files. This directory contains four subdirectories:
 - /INV: inverter data.
 - /TIC: electric meter data.
 - /IO: Analogue and digital input/output data, and index entries.
 - /MODBUS: Modbus data.

- /ID: Identification files for the gateway.
- /ALARM: Contains the alarm files.
- /CMD: Contains the command and acknowledgement files.
- /LOG: Contains the gateway system log (IDSite_DATE.log) and the debug trace log (disabled by default, and used only by Webdyn in support mode) IDSite_DATE_debug.log.

It is possible to modify part of the directory tree of the FTP server by modifying the root directories (“/CONFIG”, “/DEF”, “/DATA”, “/BIN”, “/ALARM”, “/CMD” and “/LOG”) in the configuration of the WebdynSun gateway.

5.2 Access to the NTP Server

To set its date and time correctly, the WebdynSun synchronises itself with an NTP server before each connection to the FTP server. By default, the gateway is configured to synchronise itself with the NTP server “pool.ntp.org”. As this NTP server is accessible via the Internet, the gateways must have valid Internet access (the UDP port 123 must be open for outgoing traffic) for synchronisation to occur.

5.3 Connection via GPRS or Ethernet

Access to the FTP and NTP servers may be via an Ethernet connection or a GPRS connection.

5.3.1 Ethernet Connection

For connection via Ethernet, the following parameters must be supplied:

- IP address of the WebdynSun on the local network.
- Subnet mask.
- IP address of the router or ADSL modem.
- IP address of the DNS server.

5.3.2 GPRS Connection

For connection via GPRS, it is essential to procure an activated SIM card with a DATA option, and to know the values of the following parameters:

- APN (Access Point Name): Name of the GPRS access point. This depends on the operator and the type of subscription.
- User name and password for connection to the APN.

5.3.3 Managing the PIN Code for the SIM Card

For connection via GPRS, a card must be inserted into the WebdynSun gateway. The PIN code to enable access to the card cannot be entered on the gateway. The WebdynSun unit handles the PIN code for the

SIM card automatically. It is for that reason that the SIM card must either be initialised with no PIN code or with a PIN code set to 0000 when it is first inserted.

The PIN code is managed using the following methods:

- If the PIN code is deactivated: GPRS communication is operational for the gateway.
- If the PIN code is activated and equal to “0000”: when the gateway is fired up for the first time, a new PIN code is attributed to the SIM card. This PIN code is defined on the basis of the ICCID (Integrated Circuit Card Identification) number of the SIM card installed. It is calculated using a proprietary Webdyn algorithm. This feature allows fraudulent use of the SIM card to be prevented, while providing ease of use.

In addition, this same SIM card can be reused in another WebdynSun or WebdynTIC unit without any additional configuration.

- If the card has a PIN code that is activated but is neither “0000” nor the code attributed by the WebdynSun gateway, communications (including SMSs) will not be operational.



Never insert a SIM card with an activated PIN code that is neither “0000” nor a value attributed by a WebdynSun. If you do so, the SIM card will be blocked and the user will have to unblock it by entering the PUK code manually.

6. Configuring the Unit

Configuration of the WebdynSun gateway should be carried out in several stages. The first stage, initialisation, consists of configuring the WebdynSun gateway so that it can connect to the FTP server. During this stage, it is also possible to trigger the detection of inverters or meters so that these items can be included in the configuration that will be uploaded to the FTP server. The second stage is configuration of the gateway via the remote server. During this stage, it is possible to modify the whole set of configuration parameters via the files available on the server, as well as to trigger the commands to detect inverters or meters.

6.1 Roles of the WebdynSun Files

Except for the locally accessible parameters enabling connection to the remote FTP server, all configuration of the unit is performed via the configuration files available on the said server. The files available on the FTP server must be in ANSI format.

Each configuration file is prefixed with a unique identifier named the “prefixID”. This prefix enables the configuration for each gateway on the server to be customised. Two categories of files are necessary for configuring the unit: the configuration files and the definition files.

The WebdynSun gateway does not overwrite the configuration and definition files available on the server. Care must be taken to maintain consistency between the configuration of the gateway and the files on the server. Where the configuration is modified locally, it is advisable to delete the files from the server so that the gateway will recreate them. Conversely, if one of the files on the server is modified, the gateway detects this and will download it. The standard configuration of the gateway is thus overwritten.

6.1.1 Configuration Files

The WebdynSun has three configuration files:

- prefixID_config.ini: this contains the general parameters of the WebdynSun.
- prefixID_daq.ini: this contains the parameters required for data acquisition.
- prefixID_var.ini: this contains the information for scheduling connection and data acquisition times.

These 3 files are contained in the configuration directory on the FTP server. By default, this directory is “/CONFIG”, but can be modified by means of the variable “FTP_DirConfig” in the file prefixID_config.ini.

If the gateway does not detect these files on the FTP server, it creates them from its current configuration. Furthermore, at every connection to the server, the gateway checks the modification dates and sizes of the files, in order to detect any modification of one of the files. Should a modification be detected, the file is downloaded by the gateway.

The details of each parameter in the configuration files will be explained as required in the remainder of this documentation.

6.1.2 Definition Files

The role of the definition file is to define the set of data to be collected for a given type of module. It may be generated automatically by the WebdynSun unit or created by the IT department depending on the specific details of the module that is to be managed.

The WebdynSun therefore possesses as many definition files as there are types of module to be controlled.

The link between the definition files and the unit is provided via the configuration file prefixID_daq.ini.

A detailed description of an inverter definition file is provided in the inverter-specific appendices.

6.2 Initialization

Initial configuration of the unit is necessary to enable connection to the remote FTP server. This configuration can be carried out either via the built-in Web server, or by SMS if this option is available where connection is done using GPRS.

Local configuration of the WebdynSun affects only the variables in the configuration file: prefixID_config.ini.

Here is a list of the variables accessible via the local web interface (http) and/or via SMS commands:

VARIABLE	DEFINITION	DEFAULT VALUE	HTTP	SMS
ID	Gateway identifier	IP Services	IP Services	IP Services
INV_Type	Type of inverter protocol used: 0= SMA: SMA Net 1= PowerOne: Aurora 2= Schneider Electric: SunEzy 3= Kaco: Powador 4= Ingeteam 5= LTI 6= Fronius 7= Schneider ConextCom 8= Danfoss ComLynx 9= PowerOne (Manual addressing) 10= Siemens PVM /Refusol 11= DiehIAko Platinum 12= SMA CENTRAUX Modbus TCP 13= SOCOMEC SunSysHome 14= SOCOMEC SunSysPro 15= reserved 16= Ingeteam Modbus TCP 17= SolarMax MaxComm 18= Delta	0	X	
	IP address of the gateway (router) on the LAN (local area network). Communication via Ethernet	192.168.1.12	X	

LAN_IpAddr	(up to 15 characters)	255.255.255.0	X	
LAN_SubnetMask	LAN subnet mask. Communication via Ethernet	0.0.0.0	X	
LAN_Gateway	(up to 15 characters)	0.0.0.0	X	
LAN_DNS	Address of the gateway (router) on the LAN. Communication via Ethernet	0	X	
LAN_DHCP_Enable	Enable/Disable DHCP: For automatic provision of Ethernet IP addresses. 0=Disabled; 1=Enabled	m2minternet	X	X
GPRS_APN	GPRS Access Point Name (APN). Provided by mobile operator (up to 29 characters)	sfr	X	X
GPRS_Login	GPRS APN identifier. Provided by mobile operator (up to 29 characters)	sfr	X	X
GPRS_Password	GPRS APN password. Provided by mobile operator (up to 29 characters)	*99***1#	IP Services	IP Services
GPRS_PhoneNumber	Phone number for GPRS. In France: *99***1# (up to 13 characters)		X	X
FAI_PhoneNumber	Phone number for PSTN. Provided by the Internet. Service Provider (ISP) (up to 13 characters)	empty	X	
FAI_Login	PSTN identifier. Provided by the ISP (up to 29 characters)	empty	X	
FAI_Password	PSTN password. Provided by the ISP (up to 29 characters)	empty	X	

WAN_Connection Interface	Remote server connection interface selected: 0=Ethernet; 1=modem (GPRS or PSTN depending on unit version)	1	X	
FTP_Server	Name of remote FTP server (up to 29 characters)	empty	X	X
FTP_Login	Identifier for connection to remote FTP server (up to 29 characters)	empty	X	X
FTP_Password	Password for connection to remote FTP server (up to 29 characters)	empty	X	X
FTP_Port	Port used for connection to remote FTP server	21	X	X
FTP_DirConfig	FTP directory name for gateway configuration files (up to 29 characters)	/CONFIG	X	
FTP_DirDef	FTP directory name for gateway definition files (up to 29 characters)	/DEF	X	
FTP_DirData	FTP directory name for data files (up to 29 characters)	/DATA	X	
FTP_DirLog	FTP directory name for log files (up to 29 characters)	/LOG	X	
FTP_DirBin	FTP directory name for gateway firmware. Used for upgrading gateway (up to 29 characters)	/BIN	X	
FTP_DirAlarm	FTP directory name for alarm files (up to 29 characters)	/ALARM	X	
FTP_DirCmd	FTP directory name for command files (up to 29 characters)	/CMD	X	

FTP_Option	Enable/Disable of two-phase data uploading. (File with extension ".tmp" uploaded, then extension ".tmp" deleted after transfer. 0=Disabled; 1=Enabled	0	X
WebService_Enabled	Enable/Disable of web services: 0= Disabled; 1= Enabled	0	X
WebService_Url	Web Service http:// address (up to 29 characters)		X
Language	Language chosen for built-in website: fr = French; en= English	fr	X

These variables can be modified at any time on the remote server.

 The server configuration always overrides the local configuration via the web interface. Please ensure that the two configurations are consistent.

 To ensure consistency between the server and the unit, it is advisable to delete the unit's configuration file prefixID_config.ini from the remote server as soon as any local modification is carried out. This must be done before connecting, so that the gateway can upload its new prefixID_config.ini configuration file.

6.2.1 Configuration via the Built-In Web Server

Access to the built-in Web interface on the WebdynSun gateway is provided via the gateway's LAN connection. As the gateway does not cross Ethernet signals, when there is a direct connection between the gateway and the computer, a crossover cable must be used. In addition, both the computer used and the gateway must belong to the same subnet. If the WebdynSun gateway has a static IP address (the default situation), the computer must also be configured to use a compatible static IP address.

This static address must belong to the same subnet as the WebdynSun gateway.

 On delivery, the settings for the WebdynSun gateway are as follows:

- IP address: 192.168.1.12.
- Subnet mask: 255. 255. 255.0.

Network administrator

- If your local network is managed by a network administrator, contact him or her before connecting the WebdynSun gateway up to your network.

Connecting to the built-in Web interface:

- Once your computer has been correctly configured:
- Launch your Web browser (Internet Explorer, Firefox, etc.).
- Go to the home page of the WebdynSun gateway using the browser's address bar to specify the address http://192.168.1.12.
- The following window is displayed:

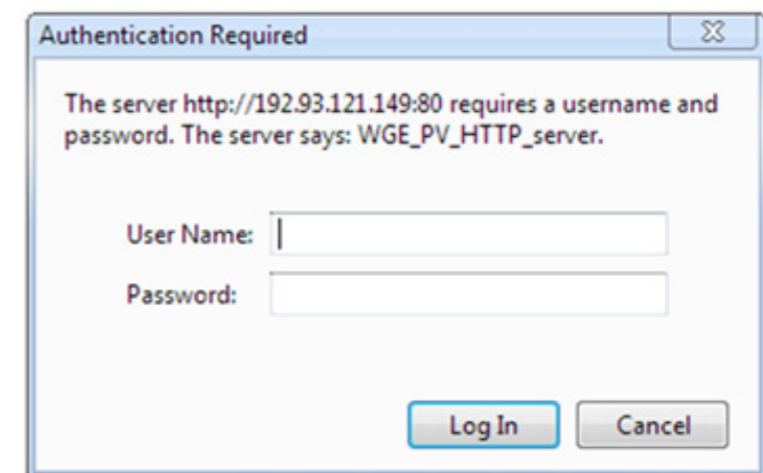

- Key in the identifier and the password:

 On delivery, the settings of the WebdynSun gateway are as follows:

User Name: userhigh

Password: high

- The following home page is displayed:



If the gateway is not yet operating, the following message is displayed:

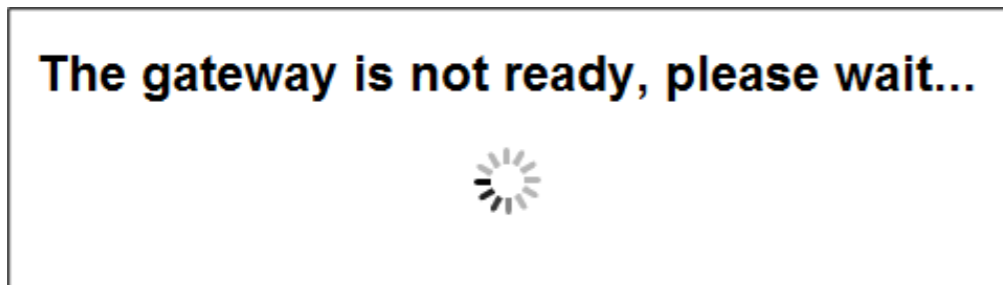

General Configuration:

The Configuration page allows you to:

- Choose the Web interface language.
- Configure the gateway identifier.
- Complete the PSTN/GPRS/Ethernet connection parameters, and the http/ftp servers.
- Choose the inverter protocol to be used.

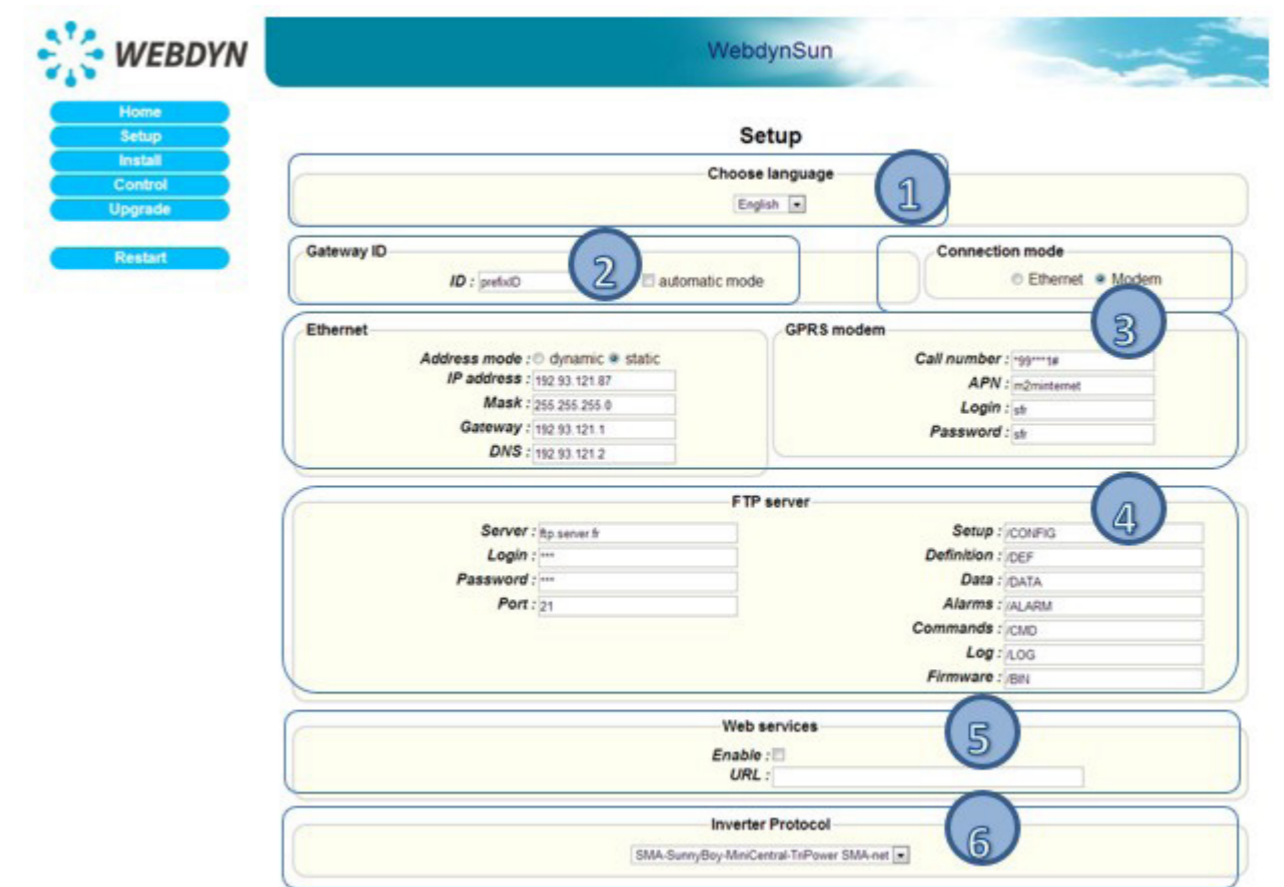

1. Choosing the Language:

Select the Web interface language from the popup menu.

This field corresponds to the variable "Language" in the configuration file prefixID_config.ini.

2. Gateway Identifier:

This field corresponds to the variable "ID" in the configuration file prefixID_config.ini. The value of this variable enables identification of the gateway when interacting with the FTP server. The names of the files available on the server will be prefixed with the value of this variable, so as to link them to the gateway (i.e. the site) concerned.

There are two ways of configuring the gateway identifier:

- Manually, in the ID field (by default "ID=WDXXXXXX" where XXXXXX is the last six digits of the MAC address).
- Automatically, by ticking the Automatic mode checkbox and leaving the ID field empty ("ID= "). For this option, Web Services must be enabled. The gateway will pick up its identifier just before the initial connection to the FTP server. The ID will be filled in with the value returned by the Web Services server. Should the variable "ID" be deleted once more ("ID= "), the gateway will request a new identifier on its next connection.

3. Connection Mode:

Choose “Ethernet” or “Modem”, depending on the mode to be used for the connection.

Ethernet:

If the connection mode chosen is “Ethernet”, enter parameters that are valid for your Ethernet network:

- Address mode: you can obtain the Ethernet parameters automatically if the network infrastructure and the version of the WebdynSun can handle this. If this is the case, click the dynamic radio button and consult the configuration of your DHCP server to find the IP address attributed to your gateway.
- IP Address: enter the IP address at which the WebdynSun gateway is accessible.
- Mask: enter the subnet mask for your network. This mask limits the Ethernet network to one range of defined IP addresses, and separates one network range from another.
- Gateway: enter the address of the gateway to your network. The gateway address is the IP address IP of the device that establishes the connection to the Internet. In general, the address entered here is that of the router or ADSL modem.
- DNS: enter the address of the DNS server. The DNS (Domain Name System) server translates symbolic Internet addresses (e.g. “www.webdyn.com”) into their corresponding IP addresses. Here you should enter the address of the DNS server you received you’re your Internet Service Provider (ISP). You can also enter the IP address of your router or ADSL modem.



If your Ethernet network is managed by a network administrator, contact him or her to have your WebdynSun gateway included in the existing Ethernet network.

Modem:

If the connection mode chosen is “Modem”, enter parameters that are valid for your GPRS subscription:

- Call number: enter the phone number for the GPRS connection. The default number is “*99***1#”, which is valid in most cases. This number is not the phone number of the SIM card fitted to the unit.
- APN: enter the Access Point Name (APN) supplied by your mobile operator.
- Login: enter the user ID for the APN supplied by your mobile operator.
- Password: enter the password for the APN supplied by your mobile operator.



Consult your mobile operator to obtain the information pertaining to your SIM card (APN, user ID and password).

4. FTP Server:

To enable the gateway to communicate with a remote FTP server (via Ethernet OR modem), enter the following information:

- Server: IP address or symbolic name of the remote FTP server.
- Login: user ID used by the gateway for connection to the remote FTP server.
- Password: password used by the gateway for connection to the remote FTP server.
- Port: port number used for communications with the remote FTP server (default: 21).
- Setup: name of the Configuration directory (default: /CONFIG).
- Definition: name of the Definition directory (default: /DEF).
- Data: name of the Data directory (default: /DATA).
- Alarms: name of the Alarms directory (default: /ALARM).
- Commands: name of the Commands directory (default: /CMD).
- Log: name of the Log directory (default: /LOG).
- Firmware: name of the directory for downloading new firmware (default: /BIN).



Check that the FTP directories defined actually exist on the FTP server. The gateway does not create any directories on the server.

For UNIX servers, the names are case sensitive (lower/UPPER case).

5. Web Services:

If the gateway has to use a connection to Web Services, enable this option and fill in the URL of the server.

Otherwise, disable this option.

6. Inverter Protocol:

Select the inverter protocol that you use from the popup menu.



Once all the parameters have been specified, click on OK. A message will appear at the top of the page to indicate that the gateway must be restarted to take the new parameters into account.

Click on Restart in the menu on the left and confirm this in the dialogue box:

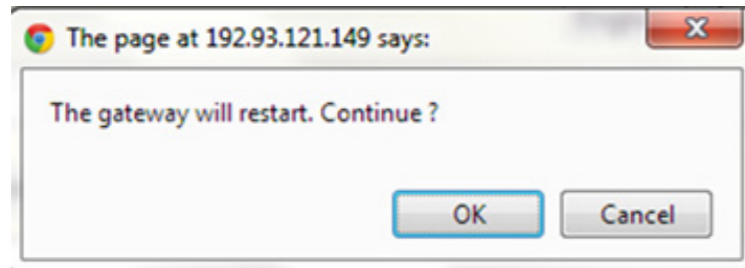

Wait for the WebdynSun gateway to complete the restart, then reconnect to the built-in Web server.



It is advisable to force connection to the remote server after restarting the unit. This is to check that all the new parameters are correct.



To ensure consistency between the server and the unit, it is advisable to delete the configuration file prefixID_config.ini from the unit before connecting. In this case, the gateway will generate and upload a new prefixID_config.ini file.

6.2.2 Configuration via SMS

It is possible to configure the information required for connection to the remote FTP server via SMS. To do so, you must first insert an active GPRS SIM card into the WebdynSun unit and ensure that you know its telephone number.

SMS to configure the APN:

Send the following SMS to the WebdynSun:

“apn=apn_name;usr=user_name;pwd=password;”

Where:

apn_name: Name of the APN.

user_name: User ID for access to the APN.

password: Password for access to the APN.

SMS to configure the remote FTP server:

Send the following SMS to the WebdynSun:

“ftp=server_name:user_name:password:port;”

Where:

server_name: Symbolic name or IP address of the remote FTP server.

user_name: User ID for access to the remote FTP server.

password: Password for access to the remote FTP server.

port: TCP port number for access to the remote FTP server (default: 21).



It is advisable to force connection to the remote server after restarting the unit. This is to check that all the new parameters are correct.

SMS to connect to the remote FTP server:

Send the following SMS to the WebdynSun:

“Connect”



To ensure consistency between the server and the unit, it is advisable to delete the configuration file prefixID_config.ini from the unit before connecting. In this case, the gateway will generate and upload a new prefixID_config.ini file.

6.3 Setting the Unit Date and Time

The WebdynSun unit timestamps all its data and log entries. As a result, it is necessary to set its time and date reliably. The real-time clock is therefore synchronised with a remote NTP server as a matter of course every time the unit connects to the Internet.

To choose an NTP server, you must modify the variables listed below in the prefixID_config.ini configuration file available on the server, then force the unit to connect to the remote server.

VARIABLE	DEFINITION	DEFAULT VALUE
NTP_Server1	IP address for the main NTP server (up to 29 characters)	pool.ntp.org
NTP_Server2	IP address for the backup NTP server (up to 29 characters)	empty

An option to force NTP resynchronisation after a restart following a power failure is enabled by setting to 1 the variable “NTP_SyncPowerLoss” in the configuration file prefixID_config.ini.

VARIABLE	DEFINITION	DEFAULT VALUE
NTP_SyncPowerLoss	Option to force NTP resynchronisation after a power failure. If this option is enabled, an NTP connection will be established after the gateway restarts following a power failure. 0=Disabled; 1=Enabled	0



All timestamping of data and events is carried out using GMT.

6.4 Connection Modes and Periods

There are four modes of connection to a remote server:

- Manual connection.
- Periodic automatic connection.
- Automatic connection at fixed times.
- Automatic connection on data capture.
- Automatic connection on alarm.

In the case of automatic connection, the connection type is chosen depending on the prefixID_var.ini configuration file.

The WebdynSun always carries out the same tasks, regardless of the type of connection requested:

- NTP synchronisation .
- Connection to the remote FTP server.
 - Alarm management.
 - Command file management.
 - Data management.
 - Upload of input/output data files.
 - Upload of electric meter files.
 - Upload of inverter data files.
 - Upload of Modbus data files.
 - Configuration file management.
 - Definition file management.
 - Log management.
 - Firmware update management.

6.4.1 Manual Connection

- Connection by pressing the push-button: you can force a connection manually by using a tool to press and hold the push-button labelled “INSTALL” until the “SERVICES” LED begins to flash rapidly.
- Connection via the built-in Web server: you can force a connection manually via the built-in Web interface by going to the “Install/Connection” menu and clicking on the “Connect” button.

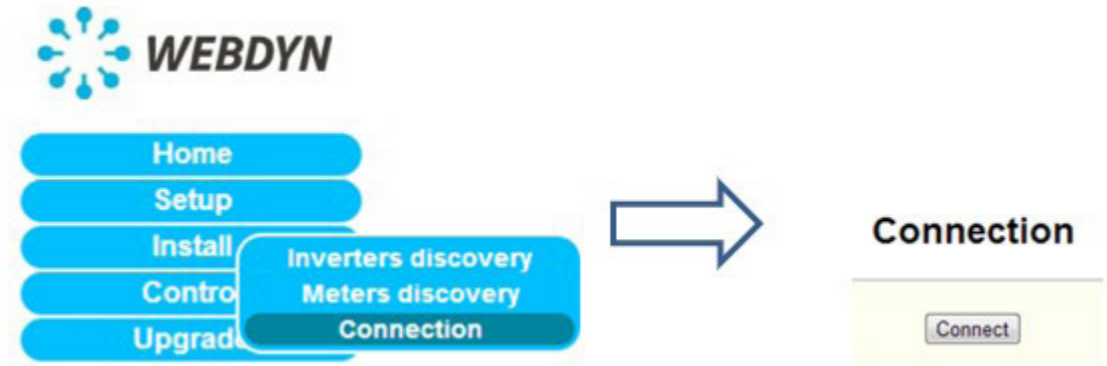

- Connection via SMS: send the SMS “connect” to the WebdynSun to force immediate connection.

6.4.2 Periodic Automatic Connection

Periodic automatic connection consists of providing the WebdynSun with a period for connection to the remote server. This period is expressed in hours and is repeated every day.

This is done by using the variables “Connection_Period”, “Connection_Hour” and “Connection_Minute” in the configuration file prefixID_var.ini.

VARIABLE	DEFINITION	DEFAULT VALUE
Connection_Period	<p>Period for connection to the remote FTP server (in hours, range 0 to 23).</p> <p>If >0: number of hours between two connections. The variable “Connection_Minute” is used to specify the minute number within the hour for the connection.</p> <p>If =0: connection every day at the time specified by the variables “Connection_Hour” and “Connection_Minute”.</p>	0
Connection_Hour	Hour for connection to the remote FTP server	1
Connection_Minute	Minute for connection to the remote FTP server	0

Example:

Configuration:

```
Connection_Period=7
Connection_Minute=25
```

Connection time:

```
Day d: 00:25, 07:25, 14:25, 21:25
Day d+1: 00:25, 07:25, 14:25, 21:25
```

6.4.3 Automatic Connection at Fixed Times

Automatic connection at fixed times consists of programming the WebdynSun with up to 5 times for connecting to the remote server per day.

This mechanism is taken into account only if the variable “Connection_Period” is equal to 0.

Programming the connection times is carried out by updating the variables listed below in the configuration file prefixID_var.ini.

VARIABLE	DEFINITION	DEFAULT VALUE
Connection_Hour	Hour for connecting to remote FTP server	1
Connection_Minute	Minute for connecting to remote FTP server	0
Connection_Hour1	Hour for connecting to remote FTP server	0
Connection_Minute1	Minute for connecting to remote FTP server	0
Connection_Hour2	Hour for connecting to remote FTP server	0
Connection_Minute2	Minute for connecting to remote FTP server	0
Connection_Hour3	Hour for connecting to remote FTP server	0
Connection_Minute3	Minute for connecting to remote FTP server	0
Connection_Hour4	Hour for connecting to remote FTP server	0
Connection_Minute4	Minute for connecting to remote FTP server	0

Example:

- Configuration:

```
Connection_Hour=7
Connection_Minute=5
Connection_Hour1=12
Connection_Minute1=10
Connection_Hour2=18
Connection_Minute2=15
```

- Connection times:

```
Day d: 07:05, 12:10, 18:15
Day d+1: 07:05, 12:10, 18:15
```

6.4.4 Automatic Connection on Data Capture

Automatic connection on data capture consists of instructing the WebdynSun to connect to the remote FTP server so as to upload the newly captured data as soon as it is available. This is configured by setting the variable “Connection_OnDataAcquisition” in the configuration file prefixID_var.ini to 1.

In this operating mode, configuration checking and time synchronisation still take place according to the parameters for connecting periodically or at fixed times as shown in the foregoing chapters.

Example:

- Configuration:

```
Connection_OnDataAcquisition=1
Connection_Period=0
Connection_Hour=23
Connection_Minute=0
```

And the data capture period is defined to be 15 minutes:

```
DAQ_Period=15
```

- Connection times:

```
Every 15 minutes for uploading data
At 23:00 for time synchronisation and configuration checking
```

6.4.5 Keeping the Connection Open

With a view to optimising the connection when automatic connection on data capture has been enabled, it is possible to keep the connection open to avoid pointless disconnections and reconnections.

This is carried out by correctly configuring the variable “Connection_WaitBeforeCloseDelay” in the configuration file prefixID_var.ini.

This delay, which is expressed in minutes, must be greater than the data acquisition time “DAQ_Period” defined in the file prefixID_daq.ini. The maximum authorised value is 59 minutes.

Example:

- Configuration:

```
Connection_OnDataAcquisition=1
Connection_WaitBeforeCloseDelay=5
Connection_Period=0
Connection_Hour=23
Connection_Minute=0
```

And the data acquisition period is defined as 2 minutes:

```
DAQ_Period=2
```

- Connection times:

```
Connection kept open with data being uploaded every 2 minutes
Time synchronisation and configuration checking occurs at 23:00 every day
```

6.4.6 Automatic Connection on Alarm

By default, the WebdynSun will trigger a connection to the remote FTP server immediately after the alarm will be detected. However, to limit the number of exchanges with FTP server, it’s possible to disable this functionality and to delay the connection at the next acquisition point. In this second case, the product will collect all the alarms and they will be uploaded to the FTP server after the next acquisition point.

To enable or disable this functionality, you must change the value of the variable « ALM_Delay » in the file prefixID_var.ini.

VARIABLE	DEFINITION	DEFAULT VALUE
ALM_Delay	0 : Alarms sent in real time	0
	1 : Alarms sent after the next acquisition point (by default 10 minutes)	

6.4.7 Optimising the Connection

To avoid excessive GPRS consumption, it is possible to enable an optimisation option for FTP communications. This is specified through the variable Connection_CheckConfigPeriod in the configuration file prefixID_var.ini.

When this optimisation is enabled, the gateway can be programmed not to analyse the configuration and definition directories on every connection.

VARIABLE	DEFINITION	DEFAULT VALUE
Connection_CheckConfigPeriod	0: disabled	0
	n: number of days between 2 analyses.	
	Note: when the gateway processes a command file, it goes on to analyse the configuration and definition directories regardless of whether optimisation has been enabled.	

Where the variable Connection_Period is zero, the time for the analysis is defined by the variable Connection_Hour. If it is not, the gateway will launch the analysis during the first connection of the day.

6.5 Acquisition Period and Time Slots

The role of the WebdynSun is to collect data from different sources (inverters, meters, sensors, etc.), and then to write them periodically to CSV files for provision via a remote FTP server.

Data collection is scheduled using the variables DAQ_Period and DAQ_PeriodSec in the configuration file prefixID_daq.ini.

VARIABLE	DEFINITION	COMMENTS	DEFAULT VALUE
DAQ_Period	Collection interval in minutes common to all data sources (inverters, TIC, I/O, Modbus)	Possible value from 0 to 59 minutes	10
DAQ_PeriodSec	Collection interval in seconds common to all data sources (inverters, TIC, I/O, Modbus)		1

 If the collection period configured is less than the real data acquisition period, the data will be timestamped at the acquisition period.

A data acquisition time slot can be defined using the variables listed below, in the file prefixID_var.ini.

VARIABLE	DEFINITION	DEFAULT VALUE
DAQ_TimeZoneStartHour	Acquisition start hour	0
DAQ_TimeZoneStartMinute	Acquisition start minute	0
DAQ_TimeZoneStopHour	Acquisition end hour	0
DAQ_TimeZoneStopMinute	Acquisition end minute	0

7. Inverter Management

The WebdynSun can manage up to 100 inverters. However, this limit may be lowered in accordance with the recommendations of each manufacturer.

The WebdynSun behaves differently according to the type and brand of inverter that you wish to monitor. This is why it is important to follow the instructions from the corresponding Appendix available on our website: <http://www.WebdynSun.com>.

Depending on the manufacturer and on the type of inverter, it is possible to:

- Detect the inverters available on the bus.
- Change the addresses of the inverters.
- Collect the list of data that can be used.
- Modify the parameters of the inverters.

The information provided below gives an overview of how the WebdynSun operates when connected to inverters, but does not replace the Appendices.

7.1 Inverter Wiring

The gateway can handle three different types of inverter architecture: RS485 Half-Duplex, RS485 Full-Duplex and Ethernet. Only one option can be chosen, and the protocol used must be selected in the configuration file prefixID_config.ini, or via the built-in Web interface from the “Configuration” menu.

For connection via RS485, it may be necessary to enable the bus termination resistors, or leave them disabled. Depending on the positioning of the gateway on the bus, this terminator must be enabled or disabled via a pair of jumpers (JMP3 and JMP2) fitted inside the casing.

Configuration of bus termination jumper
JMP3 and JMP2

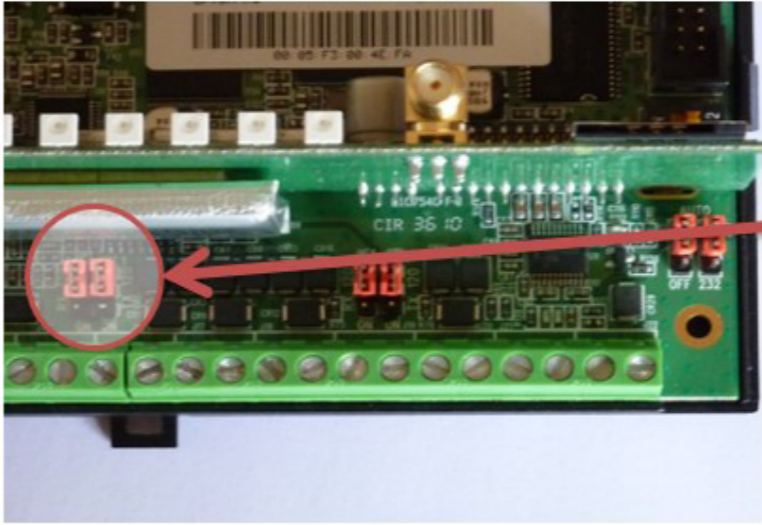

RS485 2 wires – Half Duplex

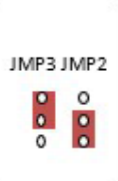
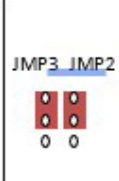
JMP3 JMP2  Enabled	JMP3 JMP2  Disabled
---	--

RS485 4 wires – Full Duplex

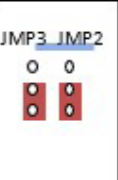
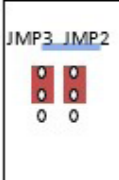
JMP3 JMP2  Enabled	JMP3 JMP2  Disabled
---	--

See the Appendix for the inverters for details of their connections and wiring.

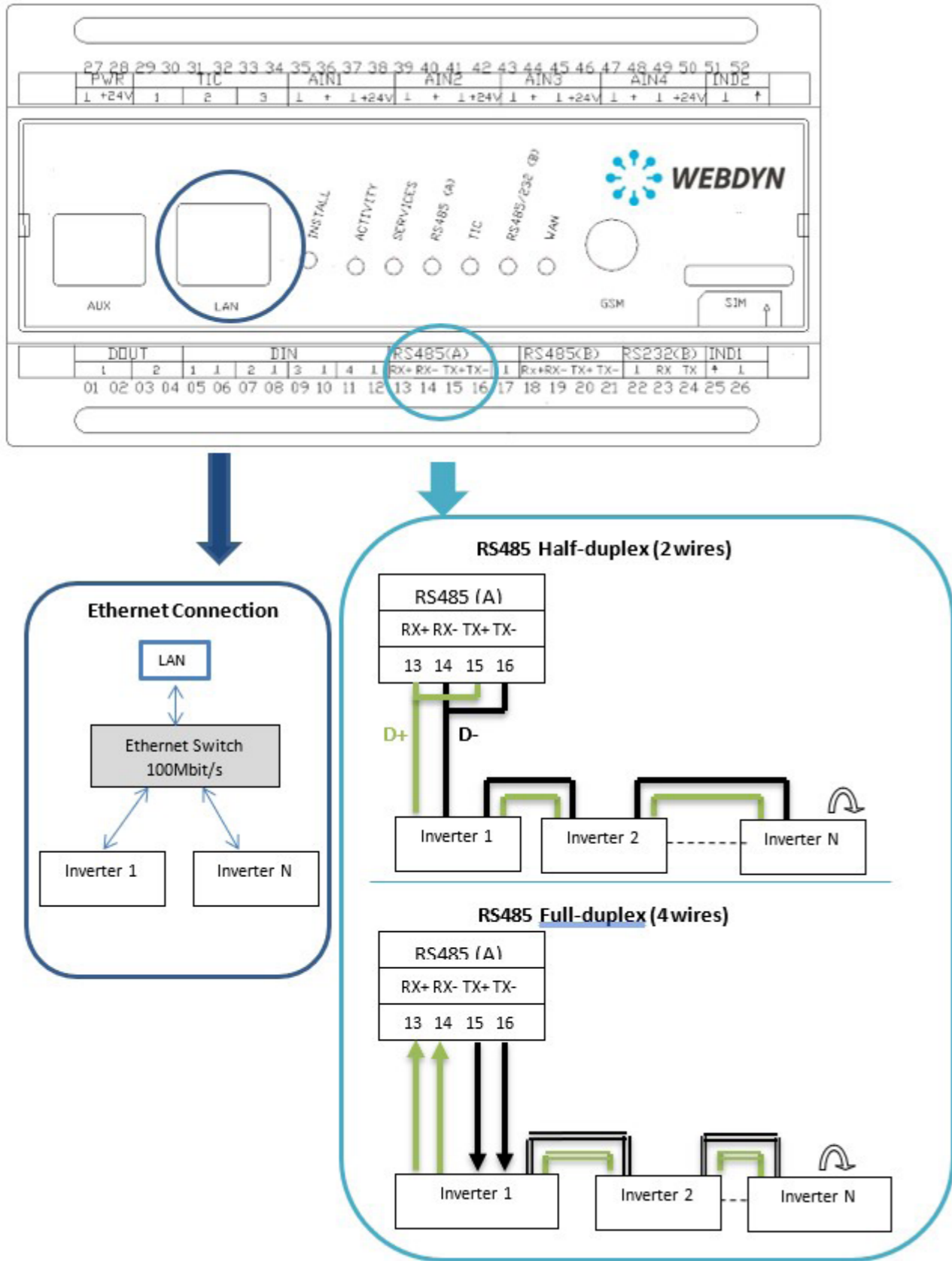

7.2 Inverter Discovery

This chapter is only applicable if the selected inverter protocol provides the facility to discover the inverters available on the network. For more details, please see the corresponding Appendix.

7.2.1 Discovering Inverters Using the Built-In Web Server

It is possible to perform inverter detection via the built-in Web server. This is triggered by going to the “Install” menu and selecting “Inverter discovery”.

To launch the detection process, follow these steps:

- Enter the number of inverters to be detected.
- Click on the “Launch” button. The following page is displayed:

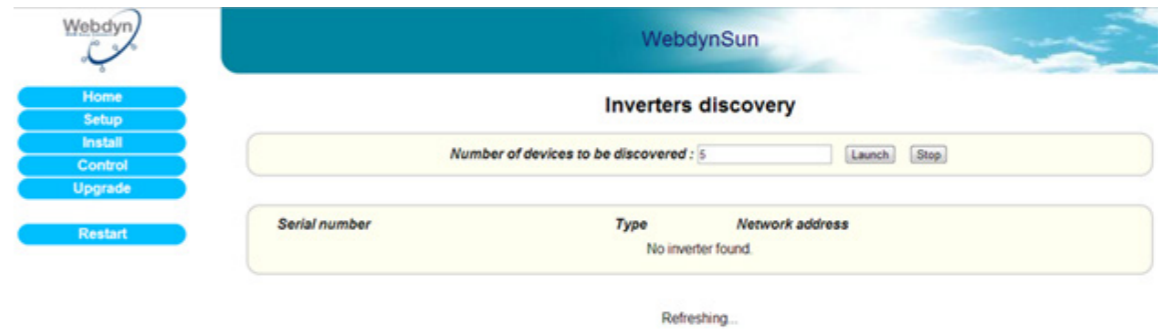

- The page refreshes itself automatically.
- Wait until the message in green text “Discovery in progress” disappears.

i While this task is being executed, no other tasks may be running. If there are any, a warning message will be displayed at the top of the page, such as: A ‘X’ task is already in progress. Please try again in a few moments.

After the search, a table is displayed at the bottom of the page, showing the types and descriptions of the inverters detected:



The discovery result is stored in a file named prefixID_INV.ini. This file is uploaded to the /CONFIG directory of the FTP server during the next connection to the server. The file contains the full set of information that characterises the inverters discovered. It complies with the following format:

```
INV_SN[n]=serialNumber
INV_Type[n]=inverterType
INV_Addr[n]=inverterAddress
```

Where:

```
n: index of the inverter discovered (0 to 99)
serialNumber: serial number of the inverter (format defined by
manufacturer).
inverterType: model number of the inverter (format defined by
manufacturer).
inverterAddress: address of the inverter on the bus (defined by
manufacturer).
```

Example:

```
INV_SN[0]=2000388220
INV_Type[0]=WR21TL09
INV_Addr[0]=0xCC00
```



Until the inverters detected are declared in the configuration file prefixID_daq.ini, no data will be collected. See the following chapter, “Declaring and configuring inverters”.

7.2.2 Discovering Inverters via a Command File

Some tasks, known as “commands”, may be requested remotely from the WebdynSun. These commands are transmitted to the gateway in the form of files uploaded to the FTP server (prefixID_CMD.csv). This file can contain several types of commands, including the command to discover inverters.

Command file: prefixID_CMD.csv.

The parameters of the commands depend on the type of command sent, as indicated below:

```
index;GATEWAY;GET_INV_NETWORK;nbInverter
```

Where:

index	1 to N: Unique identifier providing command identification
nbInverter	Number of inverters to be discovered

The command file is deleted from the server by the gateway after downloading. After the commands are executed, an acknowledgement file is sent to the server (prefixID_ACK_YMMDD_hhmmss.csv).

Acknowledgement file: prefixID_ACK_YMMDD_hhmmss.csv.

The acknowledgement file mirrors the command file, with timestamps added, and the acknowledgement:

```
Date-time;index;GATEWAY;GET_INV_NETWORK;nbInverter;;ack
```

Where ack=OK or ERROR.

The acknowledgement indicates whether the command was understood by the gateway. It gives no information as to whether inverter detection succeeded or failed.



Until the inverters detected are declared in the configuration file prefixID_daq.ini, no data will be collected. See the following section “Declaring and configuring inverters”.

7.3 Declaring and Configuring Inverters

It is essential to select the inverter protocol to be used before declaring the inverters. This is done by modifying the variable "INV_Type" in the configuration file prefixID_config.ini as follows:

VARIABLE	DEFINITION	DEFAULT VALUE
INV_Type	Type of inverter protocol used: 0= SMA: SMA Net 1= PowerOne: Aurora 2= Schneider Electric: SunEzy 3= Kaco: Powador 4= Ingeteam 5= LTI 6= Fronius 7= Schneider: ConextCom 8= Danfoss: ComLynx 9= PowerOne: (Manual addressing) 10= Siemens: PVM/Refusol 11= DiehlAko: Platinum 12= SMA CENTRAUX: Modbus TCP 13= SOCOMEC: SunSysHome 14= SOCOMEC: SunSysPro 15= reserved 16= Ingeteam: Modbus TCP 17= SolarMax: MaxComm 18= Delta	0

Each inverter to be monitored must be declared in the configuration file prefixID_daq.ini.

This can be done manually by completing the fields listed below in the file prefixID_daq.ini, or automatically after launching an inverter discovery phase, where this phase is available.

Parameters that are common to all interfaces:

VARIABLE	DEFINITION	COMMENTS	DEFAULT VALUE
DAQ_Period	Collection interval in minutes common to all data sources (inverters, TIC, I/O, Modbus)	Possible value from 0 to 59 minutes	10
DAQ_PeriodSec	Collection interval in seconds common to all data sources (inverters, TIC, I/O, Modbus) . Considered only if DAQ_Period is equal to 0	Possible value from 0 to 59 seconds	0
DAQ_HeaderOption	Enable/Disable display of column headers in the data files 0=disabled; 1=enabled		0

Generic parameters for all inverters:

VARIABLE	DEFINITION	COMMENTS	DEFAULT VALUE
INV_nbDeviceByLog	Number of INV devices per data file: 0 = all devices are in a single data file.		0

Parameters specific to each inverter:

VARIABLE	DEFINITION	COMMENTS	DEFAULT VALUE
INV_SN[n]	Serial number of inverter n	n=0 to 99	empty
INV_FileDefName[n]	Name of definition file for inverter n (up to 59 characters)	n=0 to 99	empty
INV_INFO[n]	Supplementary data used for some protocols (up to 59 characters)	n=0 to 99	empty

Example:

Declaration of 2 SunnyBoy SB 2100 TL inverters from SMA.

```
INV_SN[0]=2000499018
INV_FileDefName[0]=prefixID_INV_WR21TL09.ini
INV_SN[1]=2000509010
INV_FileDefName[1]=prefixID_INV_WR21TL0A.ini
```

To generate the file prefixID_daq.ini automatically, after launching a discovery phase, you must proceed as follows:

- Delete the file prefixID_daq.ini from the FTP server.
- Force connection between the WebdynSun and the server via the web page, the push-button or an SMS.
- The gateway will regenerate a prefixID_daq.ini file, with the local information that it has gathered during its inverter discovery phase.

7.4 Inverter Definition Files

Every inverter declared in the configuration file `prefixID_daq.ini` must have an associated definition file. The purpose of this file is to describe the whole set of variables available for the inverter.

For each variable, it describes:

- Collection method: used by the gateway to collect the data from within the inverter.
- Processing method: average, instantaneous, parameter or alarm.
- Formatting: name, unit and scaling coefficient. This file must be made available to the gateway on the FTP server.

By convention, the filename has the following format:

`prefixID_INV_inverterType.ini`,

Where: “prefixID” corresponds to the gateway identifier and “inverterType” corresponds to the type or version of the inverter.

A single file may be used for many types of inverter that behave in the same way.

An INV definition file respects the following format:

```
index;reserved1;reserved2;reserved3;name;unit;coeffA;coeffB;action
index_N;reserved1_N;reserved2_N;reserved3_N;name_N;unit_N;coeffA_N;
coeffB_N;action_N
```

Where:

<code>index_N</code>	Index of the variable to be collected (1 to n). This index must be unique within the file.
<code>reserved1_N</code> <code>reserved2_N</code> <code>reserved3_N</code>	Fields specific to the chosen inverter protocol Note: these fields are not user-modifiable
<code>name_N</code>	Variable name
<code>unit_N</code>	Variable unit
<code>coeffA_N</code>	Scaling coefficient A for the data item, using the formula $Ax + B$
<code>coeffB_N</code>	Scaling coefficient B for the data item, using the formula $Ax + B$

<code>action_N</code>	Action to be taken on the variable 0: variable not collected. 1: variable regarded as a read-only parameter 2: average values with minimum and maximum collected. 4: instantaneous value. 8: variable processed as an alarm. On change of status, triggers an alarm. 17: variable regarded as a parameter (read/ write)
-----------------------	---

7.5 Checking that Inverters are Operating Correctly

It is advisable to check that inverters are operating correctly after they have been declared in the file `prefixID_daq.ini`. This can be done via the built-in Web server by going to the “Control/Inverters” menu:

Status	Serial number	Type	Network address	Definition file
1	2000388220	WR21TL09	0xCC00	<code>prefixID_INV_WR21TL09.ini</code>
2	9343	inconnu	0x0000	<code>prefixID_INV_WR21TL0A.ini</code>

Status:
Indicates the status of the configured inverter.

- The inverter is correctly configured and communicating with the WebdynSun.
- The inverter is incorrectly configured or is not communicating with the WebdynSun.

Definition file:
Indicates the status of the definition file associated with the configured inverter.

prefixID_File.ini: file downloaded locally and valid.

prefixID_File.ini: file not downloaded locally or invalid.

You can also look at the RS485 (A) LED on the front panel of the unit to check on the activity over the RS485 (A) link. This LED flashes rapidly on reception of packets from inverters.

7.6 Inverter Data

Once it has been configured, the WebdynSun constantly collects data from the inverters, then writes it to a text file in CSV format. This file is compressed in GZ format, then uploaded periodically to the FTP server for subsequent operations.

7.6.1 Filename Syntax:

The data file uploaded to the FTP server complies with the following format:

```
prefixID_INV_f_F_YYMMDD_hhmmss.csv.gz
```

Where:

prefixID: gateway identifier.

YYMMDD_hhmmss: timestamp for the archive in the format “year-month-day-hour-minute-second”.

f: index of the inverter file (incremented if the option “INV_nbDeviceByLog” is in use).

F: total number of inverter files to be transferred (incremented if the option “INV_nbDeviceByLog” is in use).

7.6.2 Format of Inverter Data

The file format is as follows (fields in green are optional data that can be enabled or disabled in IDSite_daq.ini):

```
SNINV;sn_1;indexDevice1
TypeINV;fileDefinitionName_1
nbVariableDevice1;indexVariable_1_Device1;indexVariable_2_
Device1;indexVariable_x_Device1
date-time_1;variable_1_value_1_Device1;variable_2_value_1_
Device1;variable_x_value_1_Device1
date-time_2;variable_1_value_2_Device1;variable_2_value_2_
Device1;variable_x_value_2_Device1
date-time_n;variable_1_value_n_Device1;variable_2_value_n_
Device1;variable_x_value_n_Device1
SNINV;sn_N;indexDeviceN
TypeINV;fileDefinitionName_N
nbVariableDeviceN;indexVariable_1_DeviceN;indexVariable_2_
DeviceN;indexVariable_x_DeviceN
date-time_1;variable_1_value_1_DeviceN;variable_2_value_1_
DeviceN;variable_x_value_1_DeviceN
date-time_2;variable_1_value_2_DeviceN;variable_2_value_2_
DeviceN;variable_x_value_2_DeviceN
date-time_n;variable_1_value_n_DeviceN;variable_2_value_n_
DeviceN;variable_x_value_n_DeviceN
```

Where:

sn_N: Serial number indicated in the configuration file prefixID_daq.ini.
IndexDeviceN: index of the inverter in DDD format (001 to 100)
fileDefinitionName_N: name of the definition file associated with the inverter.
nbVariableDeviceN: number of variables collected for each inverter.
indexVariable_x_DeviceN: index of the variable collected.
date-time_n: timestamp of the data capture in YY/MM/DD-hh:mm:ss format.
variable_x_value_n: value n of variable x captured at date-time n.

With the definition file being:

```
indexVariable_1;reserved1;reserved2;reserved3;name;unit;coeffA;coeffB;
action

indexVariable_N;reserved1_N;reserved2_N;reserved3_N;name_N;unit_N;
coeffA_N;coeffB_N;action_N
```

7.6.3 Example

Acquisition every 15 minutes of the data from an SMA inverter whose serial number is 2000408440

Data file: prefixID_INV_1_1_130405_112607.csv.gz

```
SNINV;2000408440;1
TypeINV;prefixID_INV_WR21TL09.ini
20;49 (min);49 (max);49 (avg);50 (min);50 (max);50 (avg);57 (min);57 (max);
57 (avg);58 (min);58 (max);58 (avg);70;71;72;73;74;75;76;77
05/04/13-
10:30:01;137;149;148.00;660;660;660.00;5000;5000;5000.00;215;22622;
126302399;3;371;2000408440;13;0
05/04/13-
10:45:02;138;149;148.00;660;660;660.00;5000;5000;5000.00;215;22622;
126303256;3;371;2000408440;13;0
05/04/13-
11:00:02;138;149;148.00;660;660;660.00;5000;5000;5000.00;215;22622;
126304110;3;371;2000408440;13;0
05/04/13-
11:15:01;140;149;148.00;660;660;660.00;5000;5000;5000.00;215;22622;
126304961;3;371;2000408440;13;0
```

With the definition file: prefixID_INV_WR21TL09.ini:

```
1;1;0401;0102;SMA-SN ; ;0.000000;4294899968.000000;1
2;2;0401;0104;Upv-Start ;V ;125.000000;600.000000;1
3;3;0401;0104;T-Start ;s ;5.000000;300.000000;1
4;4;0401;0104;T-Stop ;s ;1.000000;300.000000;1
30;30;0401;0104;It-Fakt ; ;0.000000;150.000000;1
...
49;1;0901;0101;Upv-Ist ;V ;1.000000;0.000000;2
50;2;0901;0101;Upv-Soll ;V ;1.000000;0.000000;2
51;3;0901;0101;Iac-Ist ;mA ;1.000000;0.000000;0
52;4;0901;0101;Iac-Soll ;% ;1.000000;0.000000;0
...
57;9;0901;0101;dZac ;ohm ;0.001000;-5.000000;2
58;10;0901;0101;RErd-Start ;kilohm ;1.000000;0.000000;2
59;11;0901;0101;Uac-Srr ;V ;1.000000;0.000000;0
...
70;1;0904;0102;E-Total ;kWh ;0.001000;;4
71;2;0904;0102;h-Total ;h ;0.000278;;4
72;3;0904;0102;h-On ;h ;0.000278;;4
73;4;0904;0102;Netz-Ein ; ;1.000000;;4
74;5;0904;0102;Event-Cnt ; ;1.000000;;4
75;6;0904;0102;Seriennummer ; ;1.000000;;4
76;1;0908;0100;Status ;;;;4
77;2;0908;0100;Fehler ;;;;8
```

On the server side, a link must be set up between the data received and the corresponding definition files.

After the data are formatted, we obtain the following results:

	UPV-IST			UPV-SOLL			DZAC		
	min	max	avg	min	max	avg	min	max	avg
05/04/13-10:30:01	137 V	149 V	148.00 V	660 V	660 V	660.00 V	0.5 ohm	0.5 ohm	0.5 ohm
05/04/13-10:45:02	138 V	149 V	148.00 V	660 V	660 V	660.00 V	0.5 ohm	0.5 ohm	0.5 ohm
05/04/13-11:00:02	138 V	149 V	148.00 V	660 V	660 V	660.00 V	0.5 ohm	0.5 ohm	0.5 ohm
05/04/13-11:15:01	140 V	149 V	148.00 V	660 V	660 V	660.00 V	0.5 ohm	0.5 ohm	0.5 ohm

	E-TOTAL	H-TOTAL	H-ON	NETZ-EIN	EVENT-CNT	SERIEN NUMMER	STATUS	FEHLER
05/04/13 10:30:01	0.215 kWh	62 h	35112 h, 4 min	3	371	2000408440	13	0
05/04/13 10:45:02	0.215 kWh	62 h	35112 h, 18 min	3	371	2000408440	13	0
05/04/13 11:00:02	0.215 kWh	62 h	35112 h, 32 min	3	371	2000408440	13	0
05/04/13 11:15:01	0.215 kWh	62 h	35112 h, 46 min	3	371	2000408440	13	0

7.7 Inverter Parameters

Some inverter data is not collected constantly. These data items are identified by having the action field in the definition file set to 1. They are uploaded to the FTP server on request, either by pressing the push-button or via a command file.

The uploaded file is a compressed CSV file in GZ format. It is handled like an inverter data file, and bears the name prefixID_INV_P_YYMMDD_hhmmss.csv.gz.

Where a parameter request is made via a command file, the command is in the following format:

```
index;GATEWAY;GET_INV_PARAMS
```

After connecting, the gateway downloads its command file prefixID_CMD.csv, downloads the inverter data identified as parameters, then uploads an acknowledgement file, prefixID_ACK_YYMMDD_hhmmss.csv containing the acknowledgement of the command like that below:

```
Date-time;index;GATEWAY;GET_INV_PARAMS;;;ack
```

Where ack=OK or ERROR.

7.8 Inverter Alarms

A variable declared as an alarm (action field = 8 for the variable in the definition file) causes an alarm to be triggered if it changes its status. This alarm is written to a file in CSV format. This file is compressed into GZ format, then uploaded to the FTP server at the next acquisition time.

7.8.1 Filename Syntax

The alarm file uploaded to the FTP server complies with the following format:

```
prefixID_AL_YYMMDD_hhmmss.csv.gz
```

Where:

prefixID: gateway identifier.

YYMMDD_hhmmss: timestamp of the archive in the format "year-month-day-hour-minute-second".

7.8.2 Format of Alarms

The uploaded CSV alarm file may contain several alarms from different sources. It complies with the following format:

```
date-time_1;AlarmSource_1;fileDefinitionName_1;deviceSn_1;indexVariable_1;value_1
date-time_N;AlarmSource_N;fileDefinitionName_N; deviceSn_N;indexVariable_N;value_N
```

Where:

date-time_N: timestamp when the alarm was triggered, in format YY/MM/DD-hh:mm:ss

AlarmSource_N: source of alarm triggering: here INV.

fileDefinitionName_N: name of the definition file associated with the triggering inverter.

deviceSn_N: serial number of the triggering inverter.

indexVariable_N: index of the variable raising this alarm.

value_N: value of the variable that raised this alarm.

7.8.3 Example of Alarm File

The alarm file prefixID_AL_130404_083015.csv.gz was received after a change in the status of the variable “Fehler ” with index 77 in the definition file prefixID_INV_WR21TL09.ini for the SMA inverter 2000408020.

The file contains the following information:

```
04/04/13-08:27:23;INV;prefixID_INV_WR21TL09.ini;2000408020;77;28
04/04/13-08:27:33;INV;prefixID_INV_WR21TL09.ini;2000408020;77;0
```

8. TIC (Smart) Meter Management

This chapter describes the operations of the WebdynSun in conjunction with smart electric meters that have a Télé-Information-Client (TIC) output [to provide Remote Customer Information—RCI]. The gateway is compatible with the following French meters:

- “Bleu” electronic single-phase multi-tariff meter (CBEMM)
- “Bleu” electronic single-phase multi-tariff meter (CBEMM – ICC version)
- “Bleu” electronic three-phase multi-tariff meter (CBETM).
- “Jaune” electronic meter (CJE)
- “Interface Clientèle Emeraude” meter (ICE)
- “Interface Clientèle Emeraude à quatre quadrants” meter (ICE-4Q)
- “PME-PMI” meter

The TIC inputs on the gateway conform to the appropriate ERDF specification version 4 (ERDF-NOI-CPT_02E). To ensure that both the gateway and the meters operate correctly and comply with the characteristics of the TIC bus, check with the recommendations of ERDF.

8.1 Smart Meter Wiring

Access to the remote information from a smart meter is via 2 terminals. To ensure that it operates correctly, the system must have a maximum bus length of 500 m and use a telephone-type cable with the characteristics described in the following clauses:

- Twisted pair, with foil shield and drain.
- Monofilament copper conductors with diameter 0.5 mm.
- PVC insulation.

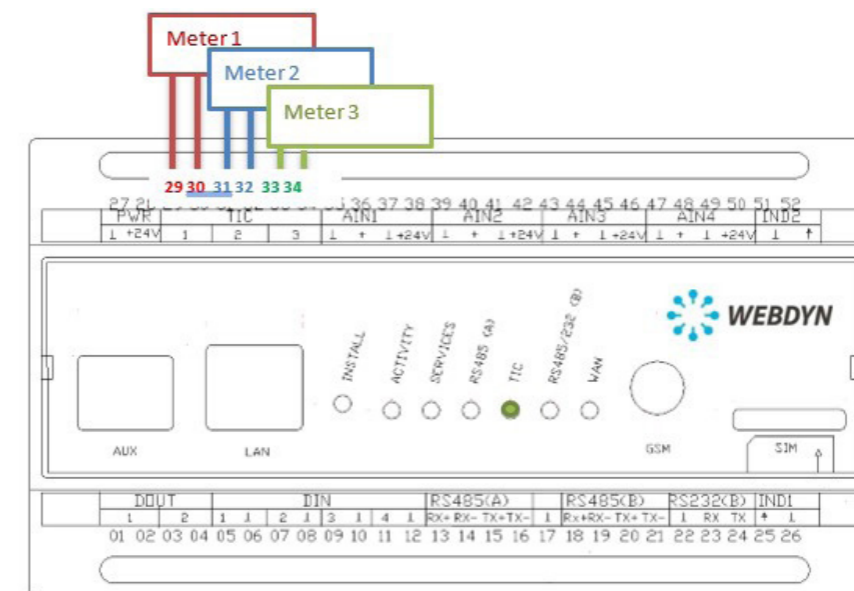

Special case: connecting an PME-PMI meter:

The electrical interface of an PME-PMI meter is different from that of other types of meter, as it requires polarisation. In addition, the remote customer data (TIC) interface connector is an RJ45 connector, and the communication speed is configurable on the meter.

Consequently, access to the meter should be provided via a series cable with a male RJ45 connector (patch cable) linked to two wires. And the speed of this bus must be defined as 1200 baud on the meter.

The wiring of the RJ45 plug is as follows:

RJ45 PINS	DESIGNATION	WEBDYN SUN PINS	SIGNAL
4	Signal ground	29 for TIC1 31 for TIC2 33 for TIC3	GND
6	Data send	30 for TIC1 32 for TIC2 34 for TIC3	Tx

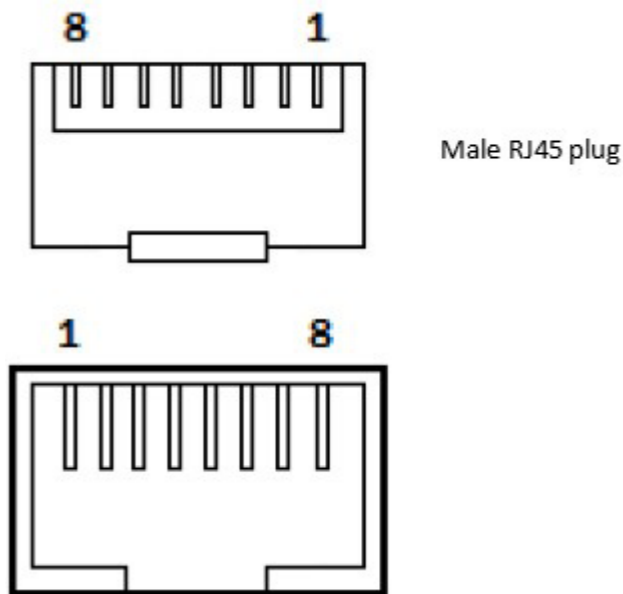

8.2 Smart Meter Discovery

8.2.1 Discovering Meters Using the Built-In Web Server

It is possible to perform meter detection via the built-in Web server. This is triggered by going to the “Install” menu and selecting “Meter discovery”.

To launch the detection process, follow these steps:

- Click on the “Launch” button. The following page is displayed:



- The page refreshes itself automatically.
- Wait until the message in green text “Discovery in progress” disappears.

i While this task is being executed, no other tasks may be running. If there are any, a warning message will be displayed at the top of the page, such as: A ‘X’ task is already in progress. Please try again in a few moments.

After the search, a table is displayed at the bottom of the page, showing the types and descriptions of the meters detected:

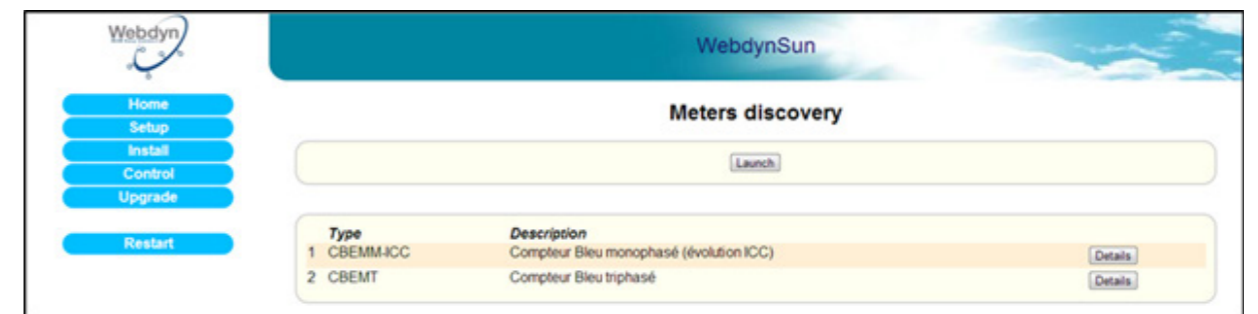

If you click on Details, you will see a list of the variables read from the meter and their values at the moment of detection.

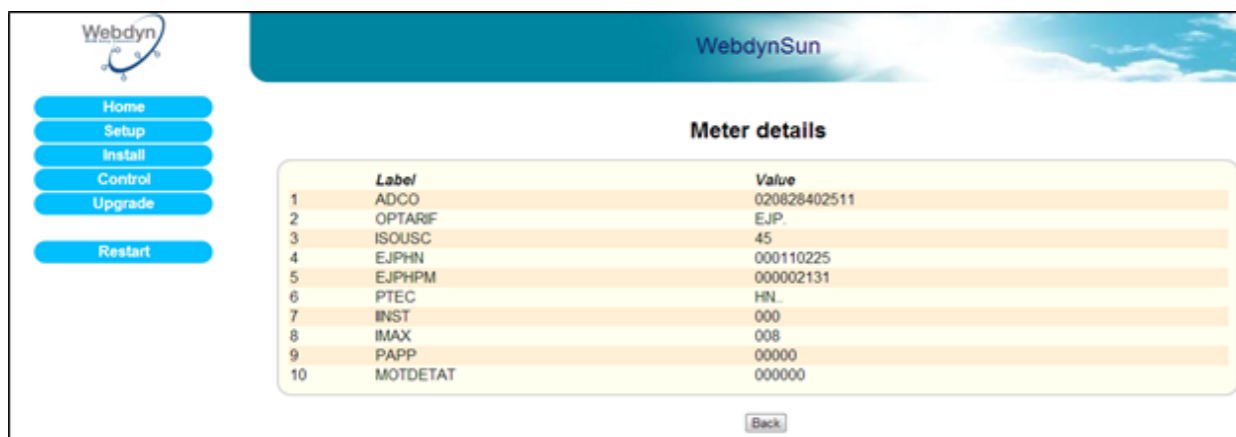

 Until the meters detected are declared in the configuration file prefixID_daq.ini, no data will be collected. See the following chapter, “Declaring meters”.

8.2.2 Discovering Meters via a Command File

Some tasks, known as “commands”, may be requested remotely from the WebdynSun. These commands are transmitted to the gateway in the form of files uploaded to the FTP server (prefixID_CMD.csv). This file can contain several types of commands, including the command to discover meters. It is deleted from the server by the gateway after downloading. After the commands are executed, an acknowledgement file is sent to the server (prefixID_ACK_YYMMDD_hhmmss.csv).

Command file: prefixID_CMD.csv.

The parameters of the commands depend on the type of command sent, as indicated below:

```
index;GATEWAY;GET_TIC_DEVICE
```

Where:

```
index      1 to N: Unique identifier providing command identification
```

Acknowledgement file: prefixID_ACK_YYMMDD_hhmmss.csv.

The acknowledgement file mirrors the command file, with timestamps added, and the acknowledgement:

```
Date-time;index; GATEWAY;GET_TIC_DEVICE;;;ack
```

Where ack=OK or ERROR.

8.3 Declaring Meters

Each meter to be monitored must be declared in the configuration file prefixID_daq.ini.

This can be done manually by completing the fields listed below in the file prefixID_daq.ini, or automatically after launching a meter discovery phase.

Parameters that are common to all interfaces:

VARIABLE	DEFINITION	COMMENTS	DEFAULT VALUE
DAQ_Period	Collection interval in minutes common to all data sources (Inverters, TIC, I/O, Modbus)	Possible value from 0 to 59 minutes	10
DAQ_PeriodSec	Collection interval in seconds common to all data sources (Inverters, TIC, I/O, Modbus). Considered only if DAQ_Period is equal to 0.	Possible value from 0 to 59 seconds	0
DAQ_HeaderOption	Enable/Disable display of column headers in the data files. 0= disabled; 1= enabled		0

Generic parameters for all smart meters:

VARIABLE	DEFINITION	COMMENTS	DEFAULT VALUE
TIC_Mode	Interface chosen for TIC smart meters: 0=Wired		0

Parameters specific to each meter:

VARIABLE	DEFINITION	COMMENTS	DEFAULT VALUE
TIC_SN[n]	Serial number of meter n	n=0 to 2	empty
TIC_FileDefName[n]	Name of definition file for meter n (up to 59 characters)	n=0 to 2	empty

Example:

Declaration of a “Blue” three-phase meter on the TIC 1 input.

```
TIC_Mode=0
TIC_SN[0]=1
TIC_FileDefName[0]=prefixID_TIC_CBEMT.ini
```

To generate the file prefixID_daq.ini automatically, after launching a discovery phase, you must proceed as follows:

- Delete the file prefixID_daq.ini from the FTP server.
- Force connection between the WebdynSun and the server via the web page, the push-button or an SMS.
- The gateway will regenerate a prefixID_daq.ini file, with the local information that it has gathered during its meter discovery phase.

8.4 Meter Definition Files

Each type of meter is characterised by its definition file.

The purpose of this file is to list the variables to be collected.

For automatic generation of configuration files, the WebdynSun can upload the definition files for the meters it has discovered to the server.

The files generated by default are:

NAME	DESCRIPTION
prefixID_TIC_CBEMM.ini	“Bleu” electronic single-phase multi-tariff meter (CBEMM)
prefixID_TIC_CBEMM-ICC.ini	“Bleu” electronic single-phase multi-tariff meter (CBEMM – ICC version)
prefixID_TIC_CBEMT.ini	“Bleu” electronic three-phase multi-tariff meter (CBETM)
prefixID_TIC_CJE.ini	“Jaune” electronic meter (CJE)
prefixID_TIC_ICE2Q.ini	“Interface Clientèle Emeraude” meter (ICE)
prefixID_TIC_ICE4Q.ini	“Interface Clientèle Emeraude à quatre quadrants” meter (ICE-4Q)
prefixID_TIC_PME-PMI.ini	“PME-PMI” meter

If despite all, during the discovery phase, a meter is not recognised, a definition file is generated by listing the variables available at that instant. This file is named prefixID_TIC_DEF_EQPTx.ini

Where x corresponds to the TIC interface used (1, 2 or 3).

A TIC definition file respects the following format:

```
indexVariable1;label1;action1
indexVariableN;labelN;actionN
```

Where:

indexVariable	Index of the variable to be collected (1 to n). This index must be unique within the file.
label	Name of the TIC variable to be collected. This name identifies the variable in the TIC flux.
action	Action to be performed on the variable. <ul style="list-style-type: none"> • 0: variable not read. • 4: instantaneous value (default setting).



For a definition of the labels, please consult the ERDF documentation version 4 (ERDF-NOI-CPT_02E.pdf).

Example: “Blue” electronic single-phase multi-tariff meter (CBEMM)

Default definition file:

prefixID_TIC_CBEMM.ini

```

1;ADCO;4
2;OPTARIF;4
3;ISOUSC;4
4;BASE;4
5;HCHC;4
6;HCHP;4
7;EJPHN;4
8;EJPHPM;4
9;BBRHCJB;4
10;BBRHPJB;4
11;BBRHCJW;4
12;BBRHPJW;4
13;BBRHCJR;4
14;BBRHPJR;4
15;PEJP;4
16;PTEC;4
17;DEMAIN;4
18;IINST;4
19;ADPS;4
20;IMAX;4
21;HHPHC;4
22;MOTDETAT;4
    
```

8.5 Checking that Meters are Operating Correctly

It is advisable to check that meters are operating correctly after they have been declared. This can be done via the built-in Web server by going to the “Control/Meters” menu:

Status:
Indicates the status of the configured meter.

- The meter is correctly configured and communicating with the WebdynSun.
- The meter is incorrectly configured or is not communicating with the WebdynSun.

Definition file:
Indicates the status of the definition file associated with the configured TIC smart meter.

- prefixID_File.ini:** file downloaded locally and valid.
- prefixID_File.ini:** file not downloaded locally or invalid.

You can also look at the TIC LED on the front panel of the unit to check on the activity over the TIC link. This LED flashes rapidly on reception of TIC packets.

8.6 Meter Data

Once it has been configured, the WebdynSun constantly collects data from the meters, then writes it to a text file in CSV format. This file is compressed in GZ format, then uploaded periodically to the FTP server for subsequent operations.

The WebdynSun collects the data from the TIC flux and saves the data read in their raw state. Only the printable characters from the ASCII table (from 0x40 [SP] to 0x7E [~]) are written to the data files. It is therefore possible that if the flux is perturbed, some values may not be saved.

8.6.1 Filename Syntax

The data file uploaded to the FTP server complies with the following format:

```
prefixID_TIC_YMMDD_hhmmss.csv.gz
```

Where:

prefixID: gateway identifier.

YMMDD_hhmmss: timestamp for the archive in the format “year-month-day-hour-minute-second”.

8.6.2 Format of Meter Data

The file format is as follows: (fields in green are optional data that can be enabled or disabled in IDSite_daq.ini).

```
SNTIC;sn_1;NumDevice1
TypeTIC;fileDefinitionName_1
nbVariableDevice1;indexVariable_1_Device1;indexVariable_2_
Device1;indexVariable_x_Device1
date-time_1;variable_1_value_1_Device1;variable_2_value_1_
Device1;variable_x_value_1_Device1
date-time_2;variable_1_value_2_Device1;variable_2_value_2_
Device1;variable_x_value_2_Device1
date-time_n;variable_1_value_n_Device1;variable_2_value_n_
Device1;variable_x_value_n_Device1
SNTIC;sn_N;NumDeviceN
TypeTIC;fileDefinitionName_N
nbVariableDeviceN;indexVariable_1_DeviceN;indexVariable_2_
DeviceN;indexVariable_x_DeviceN
date-time_1;variable_1_value_1_DeviceN;variable_2_value_1_
DeviceN;variable_x_value_1_DeviceN
date-time_2;variable_1_value_2_DeviceN;variable_2_value_2_
DeviceN;variable_x_value_2_DeviceN
date-time_n;variable_1_value_n_DeviceN;variable_2_value_n_
DeviceN;variable_x_value_n_DeviceN
```

Where:

sn_N: Serial number indicated in the configuration file prefixID_daq.ini.

NumDeviceN: index of the meter in DDD format (001 to 003)

fileDefinitionName_N: name of the definition file associated with the meter.

nbVariableDeviceN: number of variables collected for each meter.

indexVariable_x_DeviceN: index of the variable collected.

date-time_n: timestamp of the data capture in YY/MM/DD-hh:mm:ss format.

variable_x_value_n: value n of variable x captured at date-time n.

With the definition file being:

```
indexVariable_1;label1;4
indexVariable_2;label2;4
indexVariable_x;labelx;4
```

8.6.3 Example

Acquisition every 15 minutes of the data from a “Blue” three-phase meter on the TIC 1 input:

```
SNTIC;1;001
TypeTIC;prefixID_TIC_CBEMT.ini
28;1;2;3;4;5;6;7;8;9;10;11;12;13;14;15;16;17;18;19;20;21;22;23;24;25;
26;27;28
29/03/13-12:30:01;701009361697;BASE;15;000445448;;;;;;;;;;;;;TH...;
000;000;000;002;000;000;00100;00000;;00110C;0C
29/03/13-12:45:03;701009361697;BASE;15;000445453;;;;;;;;;;;;;TH...;
000;000;000;002;000;000;00100;00000;;00110C;0C
29/03/13-13:00:01;701009361697;BASE;15;000445458;;;;;;;;;;;;;TH...;
000;000;000;002;000;000;00100;00000;;00110C;0C
29/03/13-13:15:02;701009361697;BASE;15;000445463;;;;;;;;;;;;;TH...;
000;000;000;002;000;000;00100;00000;;00110C;0C
```

With the definition file: prefixID_TIC_CBEMT.ini:

```

1;ADCO;4
2;OPTARIF;4
3;ISOUSC;4
4;BASE;4
5;HCHC;4
6;HCHP;4
7;EJPHN;4
8;EJPHPM;4
9;BBRHCJB;4
10;BBRHPJB;4
11;BBRHCJW;4
12;BBRHPJW;4
13;BBRHCJR;4
14;BBRHPJR;4
15;PEJP;4
16;PTEC;4
17;DEMAIN;4
18;IINST1;4
19;IINST2;4
20;IINST3;4
21;IMAX1;4
22;IMAX2;4
23;IMAX3;4
24;PMAX;4
25;PAPP;4
26;HHPHC;4
27;MOTDETAT;4
28;PPOT;4

```

On the server side, a link must be set up between the data received and the corresponding definition files.

After the data are formatted, we obtain the following results:

The meter with serial number 701009361697 (ADCO) is configured with the BASE tariff option (OPTARIF) and contractual current (ISOUSC) of 15 A.

The present tariff period (PTEC) during acquisition is “Every Hour” (TH..).

The maximum three-phase power attained (PMAX) is 100 W.

The index corresponding to the present tariff option went up by 15 Wh in 45 minutes.

BASE	
29/03/13-12:30:01	445448 Wh

29/03/13-12:45:03	445453 Wh
29/03/13-13:00:01	445458 Wh
29/03/13-13:15:02	445463 Wh

The instantaneous current for the three phases 1, 2 and 3 during the acquisition period collected is:

	IINST1	IINST2	IINST3
29/03/13-12:30:01	0	0	0
29/03/13-12:45:03	0	0	0
29/03/13-13:00:01	0	0	0
29/03/13-13:15:02	0	0	0

The maximum current for phases 1, 2 and 3 during the acquisition period collected is:

	IMAX1	IMAX2	IMAX3
29/03/13-12:30:01	2	0	0
29/03/13-12:45:03	2	0	0
29/03/13-13:00:01	2	0	0
29/03/13-13:15:02	2	0	0

The data values HCHC, HCHP, EJPHN, EJPHPM, BBRHCJB, BBRHPJB, BBRHCJW, BBRHPJW, BBRHCJR, BBRHPJR and PEJP are not supplied because they do not correspond to the selected tariff option.

9. Input/Output Management

This chapter describes the set of facilities that enables management of the input/output features of the WebdynSun.

The WebdynSun has:

- 4 dry contact/bang-bang inputs.
- 2 index inputs for pulse counting.
- 2 switching relay outputs.
- 4 analogue inputs configurable as 0–10 V or 4–20 mA using jumpers.

9.1 Wiring

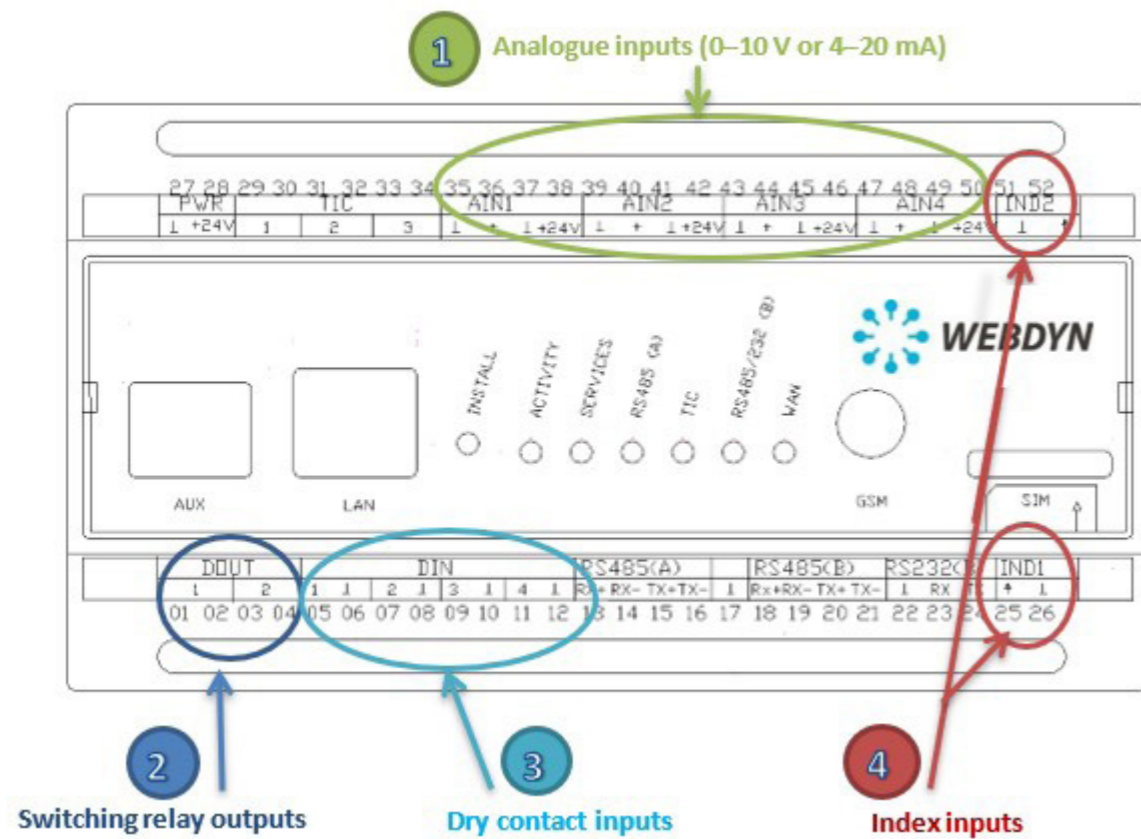

9.1.1 Analogue Inputs (0–10 V or 4–20 mA)

The WebdynSun provides 4 analogue inputs, each provided with a power output that can be used to power sensors remotely. The tension delivered by these four outputs has the same value as the tension supplying the gateway.

The earth terminals are common.

Each analogue input can be configured to range from 0 / 10 V or from 4 / 20 mA.

The choice between the two is made using jumpers on the circuit board.

The WebdynSun includes 4 analogue-to-digital converters (ADCs) whose resolution is 10 bits. The values reported are therefore digital, from 0 to 1023. To convert these to real values, scaling must be done according to the type of sensor used. This scaling must be done on the server side via the scaling coefficients A and B provided in the input/output definition file.

Example:

If we consider a linear temperature sensor whose operating range is from -50°C to $+50^{\circ}\text{C}$, the value -50°C corresponds to the digital value 0 and $+50^{\circ}\text{C}$ corresponds to 1023.

Using the $Ax + B$ formula, we obtain the scaling coefficients A and B: $A = 100/1023$ and $B = -50$.

If the gateway uploads a digital value of 748, this corresponds to $23.046875^{\circ}\text{C}$ after conversion.

Analogue input type selection (JMP5 to JMP8)

JMP5	Analogue input 1
JMP6	Analogue input 2
JMP7	Analogue input 3
JMP8	Analogue input 4

9.1.2 Switching Relay Outputs

The WebdynSun provides 2 relay outputs. The relays used are electromechanical ones intended for switching. They are not power relays. They are open when not energised, and their characteristics are:

Current ratings:

- 3 A, 48 V AC.
- 3 A, 30 V DC.

The outputs can be used in their open or closed states, or pulsed, with a pulse duration (closed) of 1 second.

 When the gateway is restarted, the bang-bang control outputs switch first to their default open states, then switch to their last configured states. Please take all possible safety precautions during this phase. So as to avoid all risks, we advise using the bang-bang control outputs in pulsed mode, especially for all power relay purposes.

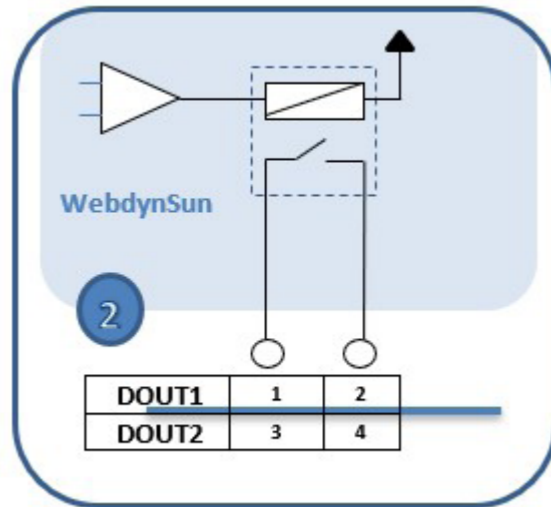

9.13 Dry Contact Inputs

The WebdynSun gateway provides 4 bang-bang inputs. These 4 inputs have a common earth and are intended to connect to dry contacts (open/closed). The maximum control impedance is 5 ohm.

 To avoid damage to the gateway, do not inject current or tension on the bang-bang inputs.

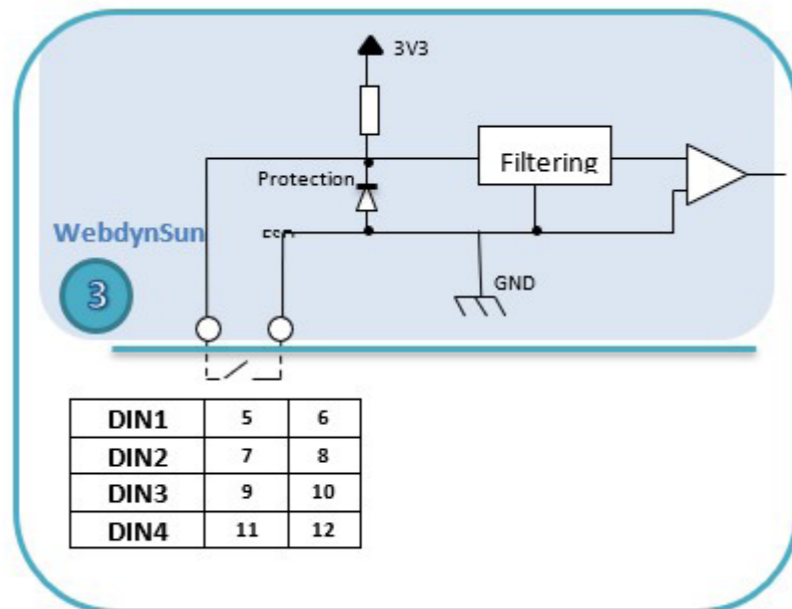

9.14 Index Inputs: Pulse Counting

The WebdynSun gateway provides two index inputs to enable pulse counting. These two inputs have a common earth connection, and are provided for dry contacts (open/closed).

A pulse is counted if its duration is between 20 ms and 1 second.

 To avoid damage to the gateway, do not inject current or tension on the index inputs.

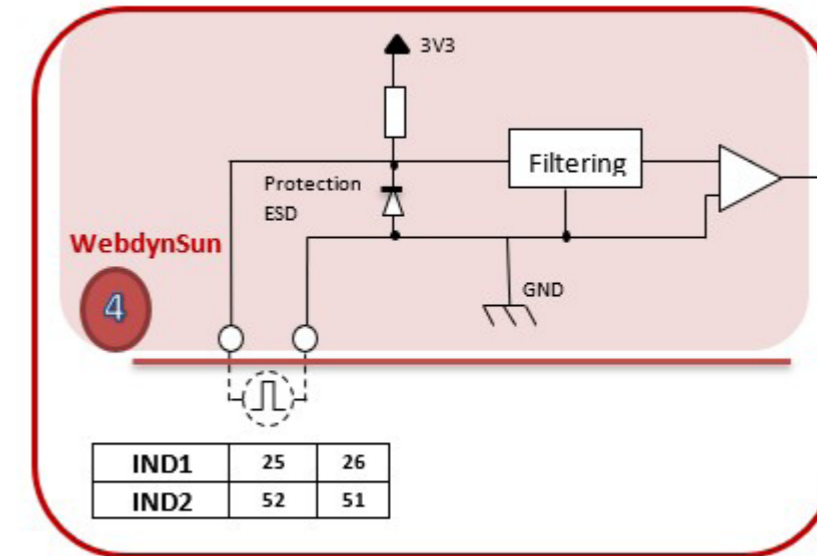

The maximum resistance allowable on the index input terminals is 50 ohm.

9.2 Declaring Input/Output Ports

The use of the input/output ports must be declared in the configuration file prefixID_daq.ini.

This can be done automatically on generation of the file prefixID_daq.ini. It can also be modified manually by altering the fields listed below in the file prefixID_daq.ini.

Parameters that are common to all interfaces:

VARIABLE	DEFINITION	COMMENTS	DEFAULT VALUE
DAQ_Period	Collection interval in minutes common to all data sources (inverters, TIC, I/O, Modbus)	Possible value from 0 to 59 minutes	10

DAQ_PeriodSec	Collection interval in seconds common to all data sources (inverters, TIC, I/O, Modbus). Considered only if DAQ_Period is equal to 0.	Possible value from 0 to 59 seconds	0
DAQ_HeaderOption	Enable/Disable display of column headers in the data files. 0= disabled; 1= enabled		0

I/O parameters:

VARIABLE	DEFINITION	COMMENTS	DEFAULT VALUE
IO_FileDefName	Name of definition file for input/output ports (up to 59 characters)		empty

9.3 Input/Output Definition Files

The set of input/output ports available on the WebdynSun is described in the definition file prefixID_IO.ini. This file respects the following syntax:

```
Index_IO_1;number_IO_1;type_IO_1;name_IO_1,coeffA_1;coeffB_1;action1
Index_IO_N;number_IO_N;type_IO_N;name_IO_N,coeffA_N;coeffB_N;actionN
```

Where:

Index_IO_N	Unique index of the variable: 1 to N
number_IO_N	Number of the input/output: 1 to 4 for the analogue input type 1 to 4 for the bang-bang input type 1 to 2 for the output type 1 to 2 for the index type

type_IO_N	Type of input/output: 1: analogue input (0–10 V or 4–20 mA) 2: bang-bang input 3: switching relay output 4: pulse counting input
name_IO_N	Name of the input/output
coeffA_N and coeffB_N	Physical conversion coefficients: for the analogue inputs, the gateway uploads a digital value ranging from 0 to 1023. To obtain a physical value, two successive conversions must be carried out: a conversion into values in the ranges 0–10 V or 4–20 mA, then a physical conversion by applying these A and B coefficients.
action_N	0: variable not collected 2: minimum, maximum and average collected 4: instantaneous variable 8: alarm

NOTE: Depending on the type of the variable, several actions are applicable. If the action defined is not consistent with the variable type, it is ignored.

TYPE OF VARIABLE	POSSIBLE ACTIONS
Analogue input	0, 2, 4
Bang-bang input	0, 4, 8
Bang-bang output	0, 4
Index	0, 4

The file generated by default is: prefixID_IO.ini

```
1;1;1;ANALOG1;1;0;2
2;2;1;ANALOG2;1;0;2
3;3;1;ANALOG3;1;0;2
4;4;1;ANALOG4;1;0;2
5;1;2;INPUT1;0;0;8
6;2;2;INPUT2;0;0;8
7;3;2;INPUT3;0;0;8
8;4;2;INPUT4;0;0;8
9;1;3;OUTPUT1;0;0;4
10;2;3;OUTPUT2;0;0;4
11;1;4;INDEX1;0;0;4
12;2;4;INDEX2;0;0;4
```

9.4 Checking that Input/Output Ports are Operating Correctly

It is advisable to check that input/output ports are operating correctly after they have been installed and configured. This can be done via the built-in Web server by going to the “Control/Input-Output” menu:

This page enables consistency checks on the values and status flags read from the various input/output devices connected. It has the appearance shown below:

The screenshot shows the 'IO control' interface with several sections:

- Analog inputs:** A table with columns for Name, Coefficients (Ax, +B), Values (Numeric, Convert), and a 'Refresh' button. A callout box explains that numerical values (0 to 1023) are converted using A and B coefficients.
- Digital inputs:** A table with Name and Status columns. All four inputs (INPUT1-4) are 'Opened'. A callout box asks for the status of bang-bang inputs (open or closed).
- Digital outputs:** A table with Name and Status columns. Both OUTPUT1 and OUTPUT2 are 'Opened'. Each row has 'Open', 'Close', and 'Pulse' buttons. A callout box asks for the status of bang-bang outputs (open or closed).
- Counter inputs:** A table with Name and Status columns. INDEX1 has a status of 0 and INDEX2 has a status of 21. A callout box asks to check bang-bang outputs (Open, Close or Pulse).

9.5 Input/Output Data

Once it has been configured, the WebdynSun constantly collects data from the input/output ports, then writes it to a text file in CSV format. This file is compressed in GZ format, then uploaded periodically to the FTP server for subsequent operations.

9.5.1 Filename Syntax

The data file uploaded to the FTP server complies with the following format:

```
prefixID_IO_YYMMDD_hhmmss.csv.gz
```

Where:

prefixID: gateway identifier.

YYMMDD_hhmmss: timestamp for the archive in the format “year-month-day-hour-minute-second”

9.5.2 Format of

9.5.3 input/Output Data

The file format is as follows (fields in green are optional data that can be enabled or disabled in IDSite_daq.ini):

```
TypeIO;fileDefinitionName
nbVariableDevice1;indexIO_1_Device1;indexIO_2_Device1;indexIO_x_
Device1
date-time_1;IO_1_value_1_Device1;IO_2_value_1_Device1;IO_x_value_1_
Device1
date-time_2;IO_1_value_2_Device1;IO_2_value_2_Device1;IO_x_value_2_
Device1
date-time_n;IO_1_value_n_Device1;IO_2_value_n_Device1;IO_x_
value_n_Device1
```

Where:

```
fileDefinitionName: name of the definition file associated with the
input/output ports.
nbVariableDeviceN: number of variables collected.
Index_IO_x_DeviceN: index of the variable collected.
date-time_n: timestamp of the data capture in YY/MM/DD-hh:mm:ss
format.
IO_x_value_n: value n of variable x captured at date-time n.
```

With the definition file being:

```
Index_IO_1;number_IO_1;type_IO_1;name_IO_1,coeffA_1;coeffB_1;action1
Index_IO_2;number_IO_2;type_IO_2;name_IO_2,coeffA_2;coeffB_2;action2
Index_IO_N;number_IO_N;type_IO_N;name_IO_N,coeffA_N;coeffB_N;actionN
```

Special case: averaged data item:

If a data item is configured as Min/Max/Average in the definition file, it will appear in the data file in the following manner:

```
nbVariableDeviceN;indexIO (min) ;indexIO (max) ;indexIO (avg) ;
date-time_n;IO_x_value_n_min;IO_x_value_n__max;IO_x_value_n_avg
```

The data values uploaded are different depending on the input/output type:

TYPE OF VARIABLE	POSSIBLE VALUES
Analogue input	0 to 1023
Dry loop (bang-bang) inputs	0 open, 1 closed
Switching relay (bang-bang) outputs	0 open, 1 closed
Index	0 to 4294967296

9.5.4 Example:

Acquisition from the input/output ports with data being saved every 5 minutes:

- 2 temperature sensors connected to the AIN1 (index 1) and AIN3 (index 3) inputs.
- 2 bang-bang inputs connected to DIN1 (index 5) and DIN2 (index 6).
- 2 outputs connected to DOUT1 (index 9) and DOUT2 (index 10).
- 1 pulse counter connected to the IND2 (index 12) input.

```
11;1 (min);1 (max);1 (avg);3 (min);3 (max);3 (avg);5;6;9;10;12
29/03/13-13:55:00;750;854;767;250;260;255;0;1;0;1;150
29/03/13-14:00:01;755;886;775;260;270;267;1;0;1;1;185
```

With the definition file: prefixID_IO.ini:

```
1;1;1;Temperature 1;0.098;-50;2
2;2;1;ANALOG2;1;0;0
3;3;1;Temperature 2; 0.098;-50;2
4;4;1;ANALOG4;1;0;0
5;1;2;Contact 1;0;0;8
6;2;2; Contact 2;0;0;8
7;3;2;INPUT3;0;0;0
8;4;2;INPUT4;0;0;0
9;1;3;Switch 1;0;0;4
10;2;3; Switch 2;0;0;4
11;1;4;INDEX1;0;0;0
12;2;4;Meter 1;0;0;4
```

On the server side, a link must be set up between the data received and the corresponding definition files

After the data are formatted, we obtain the following results:

Temperature measurements:

The sensors used have a temperature range from -50°C to +50°C. As the resolution of the analogue/digital converter on the AIN1 to AIN4 inputs is 10 bits (0 to 1023), we can deduce the scaling coefficients A and B as follows:

A = 0.098 and B = -50

	TEMPERATURE 1			TEMPERATURE 2		
	min	max	avg	min	max	avg
29/03/13-13:55:00	750 (23.5°C)	854 (33.692°C)	767 (25.166°C)	250 (-25.5°C)	260 (-24.52°C)	255 (-25.01°C)
29/03/13-14:00:01	755 (23.99°C)	886 (36.828°C)	775 (25.95°C)	260 (-24.52°C)	270 (-23.54°C)	267 (-23.834°C)

In green, the values converted to degrees Celsius using the A and B coefficients from the definition file according to the conversion formula $Ax + B$.

Capture of the bang-bang inputs:

	CONTACT 1	CONTACT 2
29/03/13-13:55:00	Contact open	Contact closed
29/03/13-14:00:01	Contact closed	Contact open

Capture of the bang-bang outputs:

	SWITCH 1	SWITCH 2
29/03/13-13:55:00	Relay open	Relay closed
29/03/13-14:00:01	Relay closed	Relay closed

Capture of the pulse counter:

COUNTER1	
29/03/13-13:55:00	150 pulses
29/03/13-14:00:01	185 pulses

9.6 Alarms on the Dry Loop Inputs

The dry loop inputs can be configured as alarm triggers. This is done via the input/output definition file, by setting the action field for the relevant inputs to 8.

In this case, a change to the input status causes an alarm to be triggered. This alarm is written to a file in CSV format. This file is compressed into GZ format, then uploaded to the FTP server at the next acquisition time.

9.6.1 Syntax of the Alarms File Name

The alarms file uploaded to the FTP server complies with the following format:

```
prefixID_AL_YYMMDD_hhmmss.csv.gz
```

Where:

prefixID: gateway identifier.

YYMMDD_hhmmss: timestamp for the archive in the format "year-month-day-hour-minute-second".

9.6.2 Format of Alarms

The uploaded CSV alarm file can contain several alarms from different sources. It is in the following format:

```
date-time_1;AlarmSource1;fileDefinitionName_1;typeIO_1;indexIO_1,value
IO_1
date-time_N;AlarmSourceN;fileDefinitionName_N;typeIO_N;indexIO_N,value
IO_N
```

Where:

```
date-time_N: timestamp when the alarm was triggered, in the format
YY/MM/DD-hh:mm:ss

AlarmSourceN: source that triggered the alarm: here, I/O.

fileDefinitionName_N: name of the definition file associated with the
trigger.

typeIO_N: type of trigger: here, Input.

indexIO_N: index of the input raising the alarm.

valueIO_N: value of the input raising the alarm (0 open, 1 closed).
```

9.6.3 Example of an Alarm on a Dry Loop

Reception of the alarm file `prefixID_AL_130329_132505.csv.gz` after the “Contact 2” bang-bang input has closed. The file contains the following information:

```
29/03/13-13:21:01;IO;prefixID_IO.ini;Input;6;1
```

With the definition file: `prefixID_IO.ini`:

```
1;1;1;Temperature 1;0.098;-50;2
2;2;1;ANALOG2;1;0;0
3;3;1;Temperature 2; 0.098;-50;2
4;4;1;ANALOG4;1;0;0
5;1;2;Contact 1;0;0;8
6;2;2; Contact 2;0;0;8
7;3;2;INPUT3;0;0;0
8;4;2;INPUT4;0;0;0
9;1;3;Switch 1;0;0;4
10;2;3; Switch 2;0;0;4
11;1;4;INDEX1;0;0;0
12;2;4;Meter 1;0;0;4
```

9.7 Controlling Relays via a Command File

Some tasks, called commands, can be requested remotely from the WebdynSun. These commands are sent to the gateway in the form of files uploaded to the FTP server (`prefixID_CMD.csv`). This file can contain several types of commands, including control of the relay outputs. It is deleted from the server by the gateway after downloading. After the commands are executed, an acknowledgement file is sent to the server (`prefixID_ACK_YYMMDD_hhmmss.csv`).

Command file: `prefixID_CMD.csv`.

The parameters for the commands are different according to the type of command sent as shown below:

```
index;IO;indexIO;action
```

Where:

index	1 to N: Unique identifier providing command identification
indexIO	1 to N: Index of the device to be controlled. This index corresponds to the first field of the device described in the I/O definition file.
action	0: Open contact 1: Close contact 2: Pulse (1 s)

On receiving a command for the bang-bang outputs, the gateway forces acquisition of its bang-bang and analogue inputs, and its bang-bang outputs. Its data will therefore be available in the next I/O data file uploaded to the server.

Acknowledgement file: `prefixID_ACK_YYMMDD_hhmmss.csv`.

The acknowledgement file mirrors the command file, with timestamps added, and the acknowledgement:

```
Date-time;index;IO;indexIO;action;;ack
```

Where `ack=OK` or `ERROR`.

10. Modbus Device Management

This chapter describes the full set of features that enable the WebdynSun to manage Modbus devices. It can handle up to 247 Modbus slaves, but this limit depends both on the type of slave present on the bus and the number of variables to be collected from each device.

10.1 Bus Wiring

Communication with Modbus devices can be via RS485 (using 2 or 4 wires), RS232 or Ethernet. This choice is made using software configuration via the configuration file prefixID_daq.ini.

Where the configuration uses RS485, the gateway may be placed at the end or in the middle of the RS485 communication bus. To ensure correct operation of the RS485 data bus, it must be terminated at both ends using a 120 ohm terminator.

Depending on the positioning of the gateway on the bus, this terminator must be enabled or disabled via a pair of jumpers (JMP4 and JMP1) fitted inside the casing.

Configuration of bus termination jumper
JMP4 and JMP1

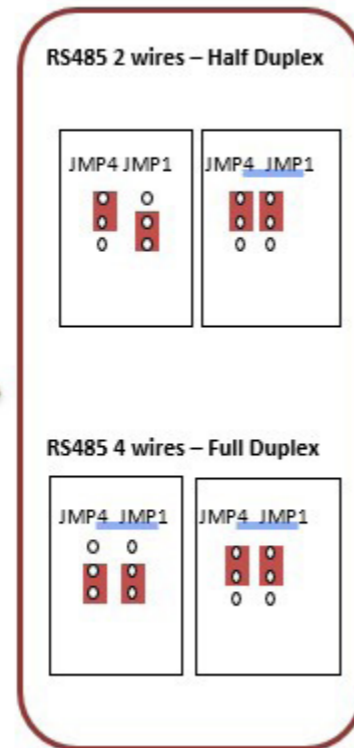
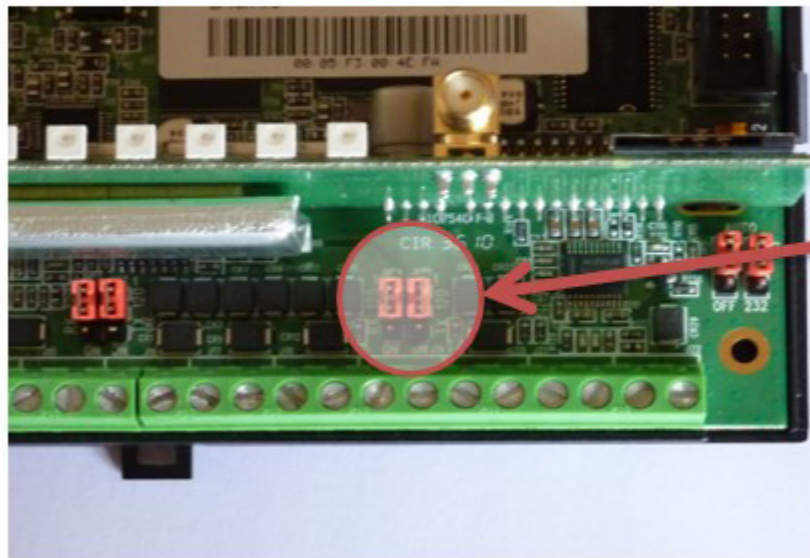

See the documentation for the Modbus devices for details of their connections and wiring.

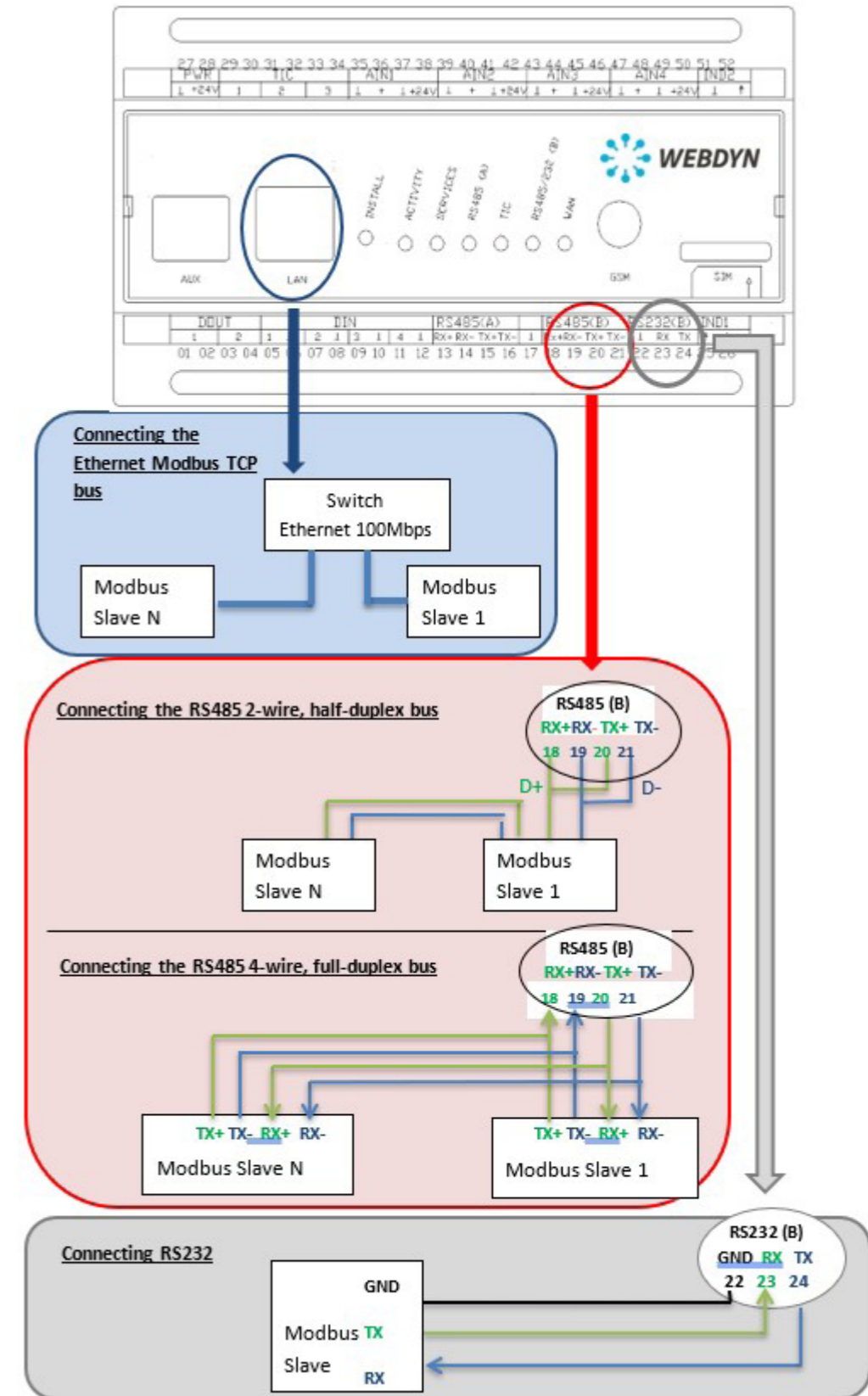

10.2 Configuring and Declaring Modbus Slave Sevicees

The WebdynSun gateway supports as well Modbus RTU that Modbus TCP equipments. RTU and TCP equipments can communicate simultaneously with the same WebdynSun gateway.

All the Modbus RTU equipments to be linked with WebdynSun has to use the same interface, the choice between RS232, RS485 2 threads or RS485 4 threads is exclusive. The associated serial connection must be configured identically for all the Modbus RTU equipments. Only the slave address must be unique for each equipment, so allowing their identification on the bus.

Unlike inverters and smart meters, discovery of Modbus devices is impossible. As a result, every device present on the bus must be declared in the prefixID_daq.ini file. This configuration is done via the FTP server.

The file prefixID_daq.ini must contain the parameters listed below:

Parameters that are common to all interfaces:

VARIABLE	DEFINITION	COMMENTS	DEFAULT VALUE
DAQ_Period	Collection interval in minutes common to all data sources (inverters, TIC, I/O, Modbus)	Possible value from 1 to 59 minutes	10
DAQ_PeriodSec	Collection interval in seconds common to all data sources (inverters, TIC, I/O, Modbus). Considered only if DAQ_Period is equal to 0.	Possible value from 0 to 59 seconds	0
DAQ_HeaderOption	Enable/Disable display of column headers in the data files. 0=disabled; 1=enabled		0

Generic parameters that characterise the bus:

VARIABLE	DEFINITION	COMMENTS	DEFAULT VALUE
MODBUS_Mode	Mode for serial communication with Modbus devices: 0: RS232 1: RS485, 2 wires 2: RS485, 4 wires	Bus RS232 or RS485 with 2 or 4 wires	1

MODBUS_BaudRate	Speed of the serial link: 1200 2400 9600 19200 38400 57600 115200		9600
MODBUS_Parity	Parity of the serial link: 0: None 1: Even 2: Odd		0
MODBUS_DataBit	Number of data bits: 8 7		7
MODBUS_StopBit	Number of stop bits: 1 2		1

Specific parameters for each Modbus slave unit:

VARIABLE	DEFINITION	COMMENTS	DEFAULT VALUE
MODBUS_Addr[n]	Address of Modbus device n between 1 and 254	n=0 to 246	1
MODBUS_Name[n]	Name of Modbus device n (up to 29 characters)	n=0 to 246	empty
MODBUS_FileDefName[n]	Name of definition file for Modbus device n (up to 59 characters)	n=0 to 246	empty
MODBUS_Type[n]	Device type: generic or specific if not 0	n=0 to 246 Used only in specific cases such as Mersen devices	0

MODBUS_Interface[n]	Medium used: 0: Serial interface (RS485/RS232) 1: Ethernet	0
MODBUS_IpAddr[n]	IP address of the device where communication is via Modbus TCP	empty

Example:

- Configuration of the bus:

Mode RS485, 2 wires, baud rate: 19200 baud, 8 data bits, 1 stop bit, no parity.

```
MODBUS_Mode=1
MODBUS_BaudRate=19200
MODBUS_DataBit=8
MODBUS_StopBit=1
MODBUS_Parity=1
```

- Declaration of Modbus slaves:

Slave 0: Mersen GreenString junction box: specific Mersen Modbus (Type 1), at address 1, named "SLAVE1" and defined by the definition file MODBUS_GREENSTRING.ini.

Slave 1: Standard Modbus device: Generic Modbus (Type 0), at address 2, named "SLAVE2" and defined by the definition file MODBUS_SLAVE.ini.

```
MODBUS_Type[0]=1
MODBUS_Addr[0]=1
MODBUS_Name[0]= SLAVE1
MODBUS_FileDefName[0]=MODBUS_GREENSTRING.ini
MODBUS_Type[1]=0
MODBUS_Addr[1]=2
MODBUS_Name[1]=SLAVE2
MODBUS_FileDefName[1]=MODBUS_SLAVE.ini
```

10.3 Structure of a Modbus Definition File

Every Modbus slave declared in the configuration file prefixID_daq.ini must have a definition file.

The purpose of this file is to describe the whole set of variables available for a Modbus device.

For each variable, it describes:

- Collection method: used by the gateway to collect the data.
- Processing method: average, instantaneous, parameter or alarm.
- Formatting: name, unit and scaling coefficient.

This file must be made available to the gateway on the FTP server.

By convention, the filename has the following format:

prefixID_MODBUS_deviceName.ini, where "prefixID" corresponds to the gateway identifier and "deviceName" corresponds to the name of the device.

A single file may be used for many devices that behave in exactly the same way. The file contains two declaration tables:

- The declaration table for Modbus requests, named "Modbus_RequestsTables": each entry in this table is defined by 10 fields separated by semicolons.

FIELD	DESCRIPTION
index	Index for the request, from 1 to N
name	Designation of the Modbus request
readFunctionCode	Read function code and function sub-code 0 to 65535 Standard codes handled: 1 => "read coils" 2 => "read discrete inputs" 3 => "read holding registers" 4 => "read input registers"
writeFunctionCode	Write function code and function sub-code 0 to 65535 Standard codes handled: 5 => "write single coils" 6 => "write single register" 15 => "write multiple coils" 16 => "write multiple registers"
startRegister	Address of the first Modbus register 0 to 65535
Size	Length of the response excluding header and CRC (in bytes) 1 to 250

enableReading	Activation of read requests: 0 => enabled in instantaneous mode (parameters) 1 => enabled in polling mode (measurements) 2 => disabled
enableWriting	Activation of write requests: 0 => write enabled with read before write 1 => write enabled, without read 2 => disabled
option1	Reserved for future use
option2	Reserved for future use

- The declaration table for variables, named "Modbus_VariablesTables": each entry in this table is defined by 12 fields separated by semicolons.

CHAMP	DESCRIPTION
index	Index for the variable, from 1 to N
indexRequest	Designation of the Modbus request, defined in the table Modbus_RequestsTables.
name	Designation of the Modbus variable
type	Type of variable 1 => bit 2 => byte 3 => word 4 => reversed word 5 => double word 6 => reversed double word 7 => floating point 8 => reversed floating point 9 => character string 10 => Specific Siebert display format
signed	Sign of the variable 1 => signed 2 => unsigned
position	Position of the variable in the packet 1 to N

option1	Reserved for future use
option2	Reserved for future use
coeffA	Scaling coefficient A for the variable (Ax +B)
coeffB	Scaling coefficient B for the variable (Ax +B)
unit	Units of the variable
action	Processing method for the variable: 0: variable not collected. 1: variable handled as a parameter. 2: minimum, maximum and calculated average collected. 4: instantaneous value 8: alarm triggered on change of status

Example:

Definition of a Modbus slave handling 4 pulse counters, 4 outputs and 4 inputs.

Declaration of Modbus requests:

	REQUEST 1	REQUEST 2	REQUEST 3
index	1	2	3
name	counter	output	input
readFunctionCode	3 (read holding registers)	1 (read coils)	3 (read holding registers)
writeFunctionCode	0	5 (write single coil)	0
startRegister	0	4	8
size	4	4	4
enableReading	1 (enabled)	1 (enabled)	1 (enabled)
enableWriting	2 (disabled)	1 (enabled)	2 (disabled)

option1	Not supplied	Not supplied	Not supplied
option2	Not supplied	Not supplied	Not supplied

```
Modbus_RequestsTables={
1;counter;3;0;0;4;1;2
2;output;1;5;4;4;1;1
3; input;2;0;8;4;1;2
}
```

Declaration of variables:

	VARIABLE 1	VARIABLE 2	...	VARIABLE 3
index	1	2		12
indexRequest	1 ("counter" request)	1 ("counter" request)		3 ("input" request)
name	counter1	counter2		input4
type	3 (word)	3 (word)		1 (bit)
signed	2 (unsigned)	2 (unsigned)		2 (unsigned)
position	1 (1st packet item)	2 (2nd packet item)		4 (4th packet item)
option1	Not supplied	Not supplied		Not supplied
option2	Not supplied	Not supplied		Not supplied
coeffA	1	1		1
coeffB	0	0		0
unit	pulse	pulse		Not supplied
action	4 (instantaneous value)	4 (instantaneous value)		8 (alarm)

```
Modbus_VariablesTables={
1;1;counter1;3;2;1;;;1;0;pulse;4
2;1;counter2;3;2;2;;;1;0;pulse;4
3;1;counter3;3;2;3;;;1;0;pulse;4
4;1;counter4;3;2;4;;;1;0;pulse;4
5;2;output1;1;2;1;;;1;0;;4
6;2;output2;1;2;2;;;1;0;;4
7;2;output3;1;2;3;;;1;0;;4
8;2;output4;1;2;4;;;1;0;;4
9;3;input1;1;2;1;;;1;0;;8
10;3;input2;1;2;2;;;1;0;;8
11;3;input3;1;2;3;;;1;0;;8
12;3;input4;1;2;4;;;1;0;;8
}
```

10.4 Checking that Modbus Devices are Operating Correctly

It is advisable to check that Modbus devices are operating correctly after they have been installed and configured. This can be done via the built-in Web server by going to the “Control/Modbus” menu:

Modbus devices control

Status	Name	Address	Definition file
✔	WebdynBridge	247	prefixID_MODBUS_TYPE1.ini
✘	WebdynBridge	1	prefixID_MODBUS_TYPE2.ini

Status:

Indicates the status of the configured Modbus device.

- ✔ The Modbus slave is correctly configured and communicating with the WebdynSun.
- ✘ The Modbus slave is not correctly configured or is not communicating with the WebdynSun.

Definition file:

Indicates the status of the definition file associated with the configured Modbus device.

prefixID_File.ini: file downloaded locally and complies with standards.

prefixID_File.ini: file not downloaded locally or not compliant with standards.

You can also look at the RS485/232(B) LED on the front panel of the unit to check on the activity over the Modbus bus. This LED flashes rapidly on reception of Modbus packets.

10.5 Modbus Data

Once it has been configured, the WebdynSun constantly collects data from the Modbus devices, then writes it to a text file in CSV format. This file is compressed in GZ format, then uploaded periodically to the FTP server for subsequent operations.

10.5.1 Filename Syntax

The data file uploaded to the FTP server complies with the following format:

```
prefixID_MODBUS_YYMMDD_hhmmss.csv.gz
```

Where:

prefixID: gateway identifier.

YYMMDD_hhmmss: timestamp for the archive in the format “year-month-day-hour-minute-second”.

10.5.2 Data Format

The file format is as follows (fields in green are optional data that can be enabled or disabled in IDSite_daq.ini):

```
ADDRMODBUS;slaveAddr_1;NumDevice1
TypeMODBUS;fileDefinitionName_1
nbVariableDevice1;indexVariable_1_Device1;indexVariable_2_Device1;indexVariable_x_Device1
date-time_1;variable_1_value_1_Device1;variable_2_value_1_Device1;variable_x_value_1_Device1
date-time_2;variable_1_value_2_Device1;variable_2_value_2_Device1;variable_x_value_2_Device1
date-time_n;variable_1_value_n_Device1;variable_2_value_n_Device1;variable_x_value_n_Device1
ADDRMODBUS;slaveAddr_N;NumDeviceN
TypeMODBUS;fileDefinitionName_N
nbVariableDeviceN;indexVariable_1_DeviceN;indexVariable_2_DeviceN;indexVariable_x_DeviceN
date-time_1;variable_1_value_1_DeviceN;variable_2_value_1_DeviceN;variable_x_value_1_DeviceN
date-time_2;variable_1_value_2_DeviceN;variable_2_value_2_DeviceN;variable_x_value_2_DeviceN
date-time_n;variable_1_value_n_DeviceN;variable_2_value_n_DeviceN;variable_x_value_n_DeviceN
```

Where:

slaveAddr_N: address of the Modbus slave (1 to 247).

NumDeviceN: index of the device in DDD format (001 to 247)

fileDefinitionName_N: name of the definition file associated with the device.

nbVariableDeviceN: number of variables collected for each device.

indexVariable_x_DeviceN: index of the variable collected.

date-time_n: timestamp of the data capture in YY/MM/DD-hh:mm:ss format.

variable_x_value_n: value n of variable x captured at date-time n.

With the definition file being:

```
# Definition of packets
# Id;Name;ReadFctCode;WriteFctCode;StartReg;NbReg;
EnableReading;EnableWriting;Option1;Option2
Modbus_RequestsTables={
1;request;3;0;0;4;1;2
}
# Definition of variables
# Id;ReqId;Name;Type;Signed;Position;Option1;Option2;
CoeffA;CoeffB,Unit,Action;
Modbus_VariablesTables={
indexVariable_1;1;data1;3;2;1;;;1;0;unit;4
indexVariable_2;1;data2;3;2;2;;;1;0;unit;4
indexVariable_x;1;data_x;3;2;3;;;1;0;unit;4
}
```

Special case averaged data item:

If a data item is configured as Min/Max/Average in the definition file, it will appear in the data file in the following manner:

```
nbVariableDeviceN;indexVariable_1(min);indexVariable_1(max);
indexVariable_1(avg);
date-time_n;variable_x_value_n_min;variable_x_value_n_max;
variable_x_value_n_avg
```

10.5.3 Example

2 Modbus devices, with acquisition every 15 minutes:

```
ADDRMODBUS;1;001
TypeMODBUS;prefixID_MODBUS_TYPE1.ini
12;1;2;3;4;5;6;7;8;9;10;11;12
27/03/13-09:45:00;32;52;5;102;1;0;1;0;0;0;0;0
27/03/13-10:00:00;35;57;5;108;1;1;0;0;0;0;0;1
ADDRMODBUS;2;002
TypeMODBUS;prefixID_MODBUS_TYPE2.ini
6;1 (min);1 (max);1 (avg);2 (min);2 (max);2 (avg)
27/03/13-09:45:00;16;32;26.00;52;58;54.00
27/03/13-10:00:00;4;6;5.50;102;105;103.00
```

Where the two definition files are:

prefixID_MODBUS_TYPE1.ini

```
# Definition of packets
# Id;Name;ReadFctCode;WriteFctCode;StartReg;NbReg;EnableReading;
EnableWriting;Option1;Option2
Modbus_RequestsTables={
1;counter;3;0;0;4;1;2
2;output;1;5;4;4;1;1
3;input;2;0;8;4;1;2
}
# Definition of variables
# Id;ReqId;Name;Type;Signed;Position;Option1;Option2;CoeffA;
CoeffB;Unit;Action;
Modbus_VariablesTables={
1;1;counter1;3;2;1;;;1;0;pulse;4
2;1;counter2;3;2;2;;;1;0;pulse;4
3;1;counter3;3;2;3;;;1;0;pulse;4
4;1;counter4;3;2;4;;;1;0;pulse;4
5;2;output1;1;2;1;;;1;0;;4
6;2;output2;1;2;2;;;1;0;;4
7;2;output3;1;2;3;;;1;0;;4
8;2;output4;1;2;4;;;1;0;;4
9;3;input1;1;2;1;;;1;0;;8
10;3;input2;1;2;2;;;1;0;;8
11;3;input3;1;2;3;;;1;0;;8
12;3;input4;1;2;4;;;1;0;;8
}
```

prefixID_MODBUS_TYPE2.ini:

```
# Definition of packets
# Id;Name;ReadFctCode;WriteFctCode;StartReg;NbReg;EnableReading;
EnableWriting;Option1;Option2
Modbus_RequestsTables={
1;voltage;3;0;0;4;1;2
}
# Definition of variables
# Id;ReqId;Name;Type;Signed;Position;Option1;Option2;CoeffA;
CoeffB;Unit;Action;
Modbus_VariablesTables={
1;1;U1;3;2;1;;;10;0;V;2
2;1;U2;3;2;2;;;10;0;V;2
}
```

On the server side, a link must be set up between the data received and the corresponding definition files.

After the data are formatted, we obtain the following results:

Device at address 1:

Counter values:

	COUNTER 1	COUNTER 2	COUNTER 3	COUNTER 4
27/03/13-09:45:00	32 pulses	52 pulses	5 pulses	102 pulses
27/03/13-10:00:00	35 pulses	57 pulses	5 pulses	108 pulses

Status of outputs:

	OUTPUT 1	OUTPUT 2	OUTPUT 3	OUTPUT 4
27/03/13-09:45:00	1	0	1	0
27/03/13-10:00:00	1	1	0	0

Status of inputs:

	INPUT 1	INPUT 2	INPUT 3	INPUT 4
27/03/13-09:45:00	0	0	0	0
27/03/13-10:00:00	0	0	0	1

Device at address 2:

Measured tension values:

	U1			U2		
	min	max	avg	min	max	avg
27/03/13-09:45:00	160 V	320 V	260 V	520 V	580 V	540.00 V
27/03/13-10:00:00	40 V	60 V	55 V	1020 V	1080 V	1050.00 V

10.6 Modbus Alarms

A variable declared as an alarm (action field = 8 for the variable in the definition file) causes an alarm to be triggered if it changes its status. This alarm is written to a file in CSV format. This file is compressed into GZ format, then uploaded to the FTP server at the next acquisition time.

10.6.1 Alarm Filename Syntax

The alarm file uploaded to the FTP server complies with the following format:

```
prefixID_AL_YYMMDD_hhmmss.csv.gz
```

Where:

prefixID: gateway identifier.

YYMMDD_hhmmss: timestamp of the archive in the format "year-month-day-hour-minute-second".

10.6.2 Format of Alarms

The uploaded CSV alarm file may contain several alarms from different sources. It complies with the following format:

```
date-time_1;AlarmSource1;fileDefinitionName;deviceName;indexVariable,value  
date-time_N;AlarmSourceN;fileDefinitionNameN;deviceNameN;indexVariableN,valueN
```

Where:

```
date-time_N: timestamp when the alarm was triggered, in format YY/MM/DD-hh:mm:ss  
AlarmSourceN: source of alarm triggering: here MODBUS.  
fileDefinitionName_N: name of the definition file associated with the triggering device.  
deviceNameN: name of the triggering device.  
indexVariableN: index of the variable raising this alarm.  
valueN: value of the variable that raised this alarm.
```

10.6.3 Example of Alarm File

The alarm file prefixID_AL_130327_100305.csv.gz was received after a change in the status of inputs input4 and input2 of the device Slave 1.

The file contains the following information:

```
27/03/13-10:01:16;MODBUS;prefixID_MODBUS_TYPE1.ini;Slave 1;12;1  
27/03/13-10:01:18;MODBUS;prefixID_MODBUS_TYPE1.ini;Slave 1;10;0
```

With the definition file prefixID_MODBUS_TYPE1.ini:

```
Modbus_RequestsTables={
1;counter;3;0;0;4;1;2
2;output;1;5;4;4;1;1
3;input;2;0;8;4;1;2
}
# Definition of variables
# Id;ReqId;Name;Type;Signed;Position;Option1;Option2;CoeffA;
CoeffB;Unit;Action;
Modbus_VariablesTables={
1;1;counter1;3;2;1;;;1;0;pulse;4
2;1;counter2;3;2;2;;;1;0;pulse;4
3;1;counter3;3;2;3;;;1;0;pulse;4
4;1;counter4;3;2;4;;;1;0;pulse;4
5;2;output1;1;2;1;;;1;0;;4
6;2;output2;1;2;2;;;1;0;;4
7;2;output3;1;2;3;;;1;0;;4
8;2;output4;1;2;4;;;1;0;;4
9;3;input1;1;2;1;;;1;0;;8
10;3;input2;1;2;2;;;1;0;;8
11;3;input3;1;2;3;;;1;0;;8
12;3;input4;1;2;4;;;1;0;;8
}
```

In the configuration file prefixID_daq.ini:

```
MODBUS_Addr[0]=1
MODBUS_Name[0]=Slave1
MODBUS_FileDefName[0]=prefixID_MODBUS_TYPE1.ini
```

After analysis of the alarm file and the definition files, we obtain the following result:

On 27/03/13 at 10:01:16 the variable input4 indexed at 12 on the device named Slave1 switched to 1.

On 27/03/13 at 10:01:18 the variable input2 indexed at 10 on the device named Slave1 switched to 0.

10.7 Writing Modbus Variables via a Command File

Some tasks, known as “commands”, may be requested remotely from the WebdynSun. These commands are transmitted to the gateway in the form of files uploaded to the FTP server (prefixID_CMD.csv). This file can contain several types of commands, including the command to write Modbus variables. It is deleted from the server by the gateway after downloading. After the commands are executed, an acknowledgement file is sent to the server (prefixID_ACK_YYMMDD_hhmmss.csv).

Command file: prefixID_CMD.csv.

The parameters of the commands depend on the type of command sent, as indicated below:

```
index;MODBUS;indexDevice;indexVariable;value
```

Where:

index	1 to N: Unique identifier providing command identification.
indexDevice	Index of the Modbus device to be configured. This index corresponds to the index used in the file daq.ini to declare the device (0 to N).
indexVariable	Index of the Modbus variable to be configured. This index corresponds to the index identifying the variable that is found in the definition file of the device to be configured.
value	Value of the parameter, in decimal or ASCII.

Acknowledgement file: prefixID_ACK_YYMMDD_hhmmss.csv.

The acknowledgement file mirrors the command file, with timestamps added, and the acknowledgement:

```
Date-time;index;MODBUS;indexDevice;indexVariable;value;ack
```

Where ack=OK or ERROR.

11. Displaying Operating Data

The WebdynSun gateway constantly collects data from inverters, smart meters, input/outputs and Modbus devices. This data set is described in definition files, which provide a link to the application server. The data values are written periodically after a configurable acquisition period (by default, every 10 minutes), then uploaded to an FTP server ready for formatting.

It is possible to display this data locally on the home page of the built-in Web server on the gateway, or on an external Modbus display.

The variables to be displayed are described in the definition file IDsite_REPORT.ini, available on the FTP server in the directory /DEF/REPORT.

The gateway can display up to a maximum of 10 variables.

Two types of variable may be distinguished:

- Cumulative variables: Power, Energy, etc.
- Instantaneous variables: Temperatures, Light levels, etc.

By default, the gateway displays the following variables in HTML format:

- Date/Time of report.
- Instantaneous power of the installation.
- Total energy produced.
- Daily energy produced.
- CO2 savings.
- Daily CO2 savings.

Four additional variables can be added to the display.

11.1 Displaying Cumulative Variables

- **Instantaneous power of the installation.**

The instantaneous power corresponds to the sum of the powers of all the inverters configured on the gateway. This variable can have different names depending on the manufacturer and the type of inverter. It is for this reason that a list of variable names is predefined in the gateway to enable it to identify the inverter variables to be added in. However, it is possible to specify a variable name in the definition file prefixID_REPORT.ini.

MANUFACTURER/PROTOCOL	DEFAULT VARIABLE NAME
SMA (SMAnet)	Pac

PowerOne (Aurora)	Grid Power
Schneider (SunEzy)	Pac
Kaco (Powador)	Grid Power
Ingeteam	AC_Power
LTI	P_AC
Fronius	Power-Now
Schneider (ConextCOM)	RealPower
Danfoss (ComLynx)	Instant Energy Production
Power One (Manual Addressing)	global Grid Power
Siemens (PVM)	AC-Power
Diehl Ako (Platinum)	AC Power
SMA (Modbus TCP)	Pac
Socomec (SunSys Home)	Inverter Wattage
Socomec (SunSys Pro)	AC output A-Wattage
Ingeteam (Modbus TCP)	Power
SolarMax (MaxComm)	AC Power
Delta	AC active power L1

- **Total energy produced.**

The total energy corresponds to the sum of the energy values from all the inverters configured on the gateway.

This variable can have different names depending on the manufacturer and the type of inverter. It is for this reason that a list of variable names is predefined in the gateway to enable it to identify the inverter variables to be added in. However, it is possible to specify a variable name in the definition file prefixID_REPORT.ini.

PROTOCOL	DEFAULT VARIABLE NAME
SMA (SMAnet)	E-Total
PowerOne (Aurora)	Total Energy
Schneider (SunEzy)	E-Total
Kaco (Powador)	E-Total
Ingeteam	Total-Energy
LTI	E_TOTAL
Fronius	EnergyTotalex
Schneider (ConextCOM)	EnergyProduced
Danfoss (ComLynx)	TotalEnergyProduction
Power One (Manual Addressing)	Total Energy Central
Siemens (PVM)	Total-Yield
Diehl Ako (Platinum)	Energy Total
SMA (Modbus TCP)	E-Total
Socomec (SunSys Home)	LifeTime Energy
Socomec (SunSys Pro)	Total Energy
Ingeteam (Modbus TCP)	Total-Energy
SolarMax (MaxComm)	Energy Total
Delta	Supplied ac energy total

- **Daily energy produced.**

The daily energy is calculated by subtracting the previous day's total energy value from the current value.

- **CO2 emissions savings.**

The CO2 emissions savings are proportional to the total energy produced. The conversion factor can be configured in the definition file.

- **Daily CO2 emissions savings.**

The CO2 emissions savings are proportional to the daily energy produced.

The conversion factor can be configured in the definition file.

11.2 Displaying Instantaneous Variables

- **Report Date/Time.**

The date and time of the report correspond to the GMT date and time when the variable were recorded.

The format of the display is DD/MM/YYYY – HH:MM (GMT).

- **Other possible variables.**

Data of TEXT type can be displayed.

All data sent by devices connected to the gateway.

Examples:

- Ambient temperature.
- Index of an electric meter.
- Modbus light level sensor, etc.

11.3 Details of the Definition File IDsite_REPORT.ini

Each line of the definition file describes the variable to be displayed.

A variable is characterised by:

FIELD	VALUES	DESCRIPTION
Index	1 to 10	Unique index of the variable to be displayed.
Enable	0 1	Disabled Enabled=> data display is operational
Type	1 2 3 4 5 6 7 8 9	Date/Time of report Instantaneous power of the installation Total energy produced Daily energy produced CO2 savings Daily CO2 savings ASCII variable Numerical variable Boolean variable

Description	Up to 60 characters	Grid Power
Unit	Up to 10 characters	AC_Power
A		P_AC
B		Power-Now
Source	0 1 2 3 4 5	RealPower
SourceVarNameExt	Up to 20 characters	Instant Energy Production
SourceIndexEq (*)	0 to N	global Grid Power
SourceIndexVar	0 to N	AC-Power
Target	0 1	AC Power
TargetIndexEq (*)	0 to N	Pac
TargetIndexVar	0 to N	Inverter Wattage
TargetFloatPrecision	0 to 6	AC output A-Wattage
TargetBooleanTrueDescription	Up to 40 characters	Power
TargetBooleanFalseDescription	Up to 40 characters	AC Power

(*) The device index: this index corresponds to the index (0 to N) provided in the file IDsite_daq.ini.

11.3.1 Default Definition File IDsite_REPORT.ini

```
1;1;1;Last acquisition;GMT;0;0;0;;0;0;0;0;0;0;;;
2;1;2;Instantaneous power;kW;1;0;1;;0;0;1;0;1;0;;;
3;1;3; Total energy produced;kWh;1;0;1;;0;0;1;0;2;0;;;
4;1;4; Daily energy produced;kWh;1;0;0;;0;0;0;0;0;2;;;
5;1;5; CO2 savings;kg;0.476;0;0;;0;0;1;0;3;0;;;
6;1;6; Daily CO2 savings;kg;0.476;0;0;;0;0;0;0;0;2;;;
```

11.3.2 Examples of IDsite_REPORT.ini Configuration

Display of variables on a Modbus screen:

```
1;1;2; Instantaneous power;kW;1;0;1;;0;0;1;0;1;0;;;
2 ;1;3; Total energy produced;kWh;1;0;1;;0;0;1;0;2;0;;;
3 ;1;5; CO2 savings;kg;0.486;0;0;;0;0;1;0;3;0;;;
```

Display of an INV variable in HTML:

```
7;1;8;TEST INV VAR;-;0;0;1;;0;87;0;0;0;2;;;
```

Display of a TIC variable in HTML:

```
8;1;7; TIC ADCO;-;0;0;2;;0;1;0;0;0;0;;;
```

Display of a Modbus variable in HTML:

```
9;1;8;MODBUS;-;0;0;4;;1;3;0;0;0;0;;;
```

Display of an I/O variable in HTML:

```
10;1;9;IO;;0;0;3;;0;1;0;0;0;2;;;
```

11.3.3 Configuring a Siebert Modbus Display

To display data on a Siebert Modbus display (using a 2-wire connection) proceed as shown below:

- Configure the display manually using the push-buttons provided for the purpose.
- Connect the Modbus display to the RS485(B) port on the WebdynSun gateway.
- Upload the definition file for the Siebert device to the FTP server, in the directory /DEF/MODBUS/.

Definition file for a Siebert Modbus display:

```
Modbus_RequestsTables={
# Description des champs
# reqIndex;reqName;reqReadFctCode;reqWriteFctCode;
reqStartRegister;reqNbRegisters;reqEnableReading;req
EnableWriting;reqOption1;reqOption2
1;Request;0;16;1;6;2;1;0;0
}

Modbus_VariablesTables={
# Description des champs
# varIndex;varReqIndex;varName;varType;varSigned;
varPosition;varOption1;varOption2;varAction
1;1;Puissance instantanée;6;2;1;;;1;0;;0
2;1;Energie cumulée;6;2;3;;;1;0;;0
3;1;Energie journalière;6;2;2;;;1;0;;0
}
```

- Update the definition file REPORT.ini on the FTP server:

```
1;1;1; Last acquisition;GMT;0;0;0;;0;0;0;0;0;0;;
2;1;2; Instantaneous power;kW;1;0;1;;0;0;1;0;1;0;;
3;1;3; Total energy produced;kWh;1;0;1;;0;0;1;0;2;0;;
4;1;4; Daily energy produced;kWh;1;0;0;;0;0;0;0;0;2;;
5;1;5; CO2 savings;kg;0.476;0;0;;0;0;0;0;3;0;;
6;1;6; Daily CO2 savings;kg;0.476;0;0;;0;0;0;0;0;2;;
```

- Update the configuration file prefixID_daq.ini on the FTP server with the following parameters: configuration of the Modbus interface (4 wires, 19200 baud, 8 data bits, 1 stop bit, no parity).

```
MODBUS_Mode=2
MODBUS_BaudRate=19200
MODBUS_Parity=0
MODBUS_DataBit=8
MODBUS_StopBit=1
```

Declaration of the Modbus device (Modbus address 1, definition file prefixID_MODBUS_SIEBERT.ini):

```
MODBUS_Addr[0]=1
MODBUS_Name[0]=SIEBERT
MODBUS_FileDefName[0]=prefixID_MODBUS_SIEBERT.ini
```

- Force the gateway to connect to the FTP server to download the new configuration.

12. Command File

It is possible to ask the WebdynSun gateway to perform certain specific tasks. This can be done via a file called the command file.

The principle is that at every connection to the remote server, the gateway checks on the existence of its command file, named `prefixID_CMD.csv`. If this file exists, it is downloaded, then executed sequentially.

Using this command file, we can therefore request the gateway to perform a discovery function for inverters or meters, or to update a device variable if the device allows this.

The name of the command file must respect the following format:

`"prefixID_CMD.csv"`

This file must be placed in the directory defined by the variable `"FTP_DirCmd"` (by default, `"/CMD"`).

After the command file has been downloaded and executed, the gateway deletes the file from the server and uploads an acknowledgement file:

`"prefixID_ACK_YYMMDD_hhmmss.csv"`

This file provides a check that the gateway has understood the commands properly.

Format of the command file:

The command file can contain several lines, with each line corresponding to one command.

`index;type;param1;param2;param3`

Where:

`index`: unique identifier for the command

`type`: command type (GATEWAY, IO, MODBUS, etc.)

`param1`, `param2` and `param3`: Parameters for the command.

Format of the acknowledgement file:

The acknowledgement file informs the operator as to whether the commands have been taken into account or not. It repeats the commands sent, and adds a timestamp and a status.

`date-time;index;type;param1;param2;param3;status`

Where:

`date-time`: Date and time when the command was executed (DD/MM/YY-hh:mm:ss)

`index;type;param1;param2;param3`: Command sent

`status`: Status of the command ("OK" or "ERROR").

12.1 GATEWAY Type Commands

Index	1 to N: Unique identifier enabling the command to be identified.
Type	GATEWAY: The command type is GATEWAY.
Parameter 1	GET_INV_NETWORK: Discovery and addressing of the inverter network. GET_TIC_DEVICE: Discovery of TIC smart meters. GET_INV_PARAMS: Upload inverter parameters.
Parameter 2	Number of inverters to be discovered via GET_INV_NETWORK.
Parameter 3	Not required.

12.2 I/O Type Commands

Index	1 to N: Unique identifier enabling the command to be identified
Type	IO: The command type is IO (Input/Output)
Parameter 1	1 to N: index of the item to command. First field of the item in the I/O def. file.
Parameter 2	0: Open contact 1: Close contact 2: Pulse (1 s)
Parameter 3	Not required

12.3 MODBUS Type Commands

Index	1 to N: Unique identifier enabling the command to be identified.
Type	MODBUS: The command type is MODBUS.
Parameter 1	Index of the Modbus device to be configured. Index used to declare the device in the <code>prefixID_daq.ini</code> file (0 to N).
Parameter 2	Index of the Modbus variable to be configured Variable identification .index present in the definition file for the device.
Parameter 3	Value of the parameter in decimal or ASCII.

13. Updating the Unit

The gateway can be updated locally via the built-in Web server, or remotely via the FTP server.

Only “.pak” files containing firmware supplied by Webdyn should be used.

13.1 Updating via the Web Server

To update your WebdynSun gateway from the “Upgrade” menu of the built-in Web server, go through the following steps:

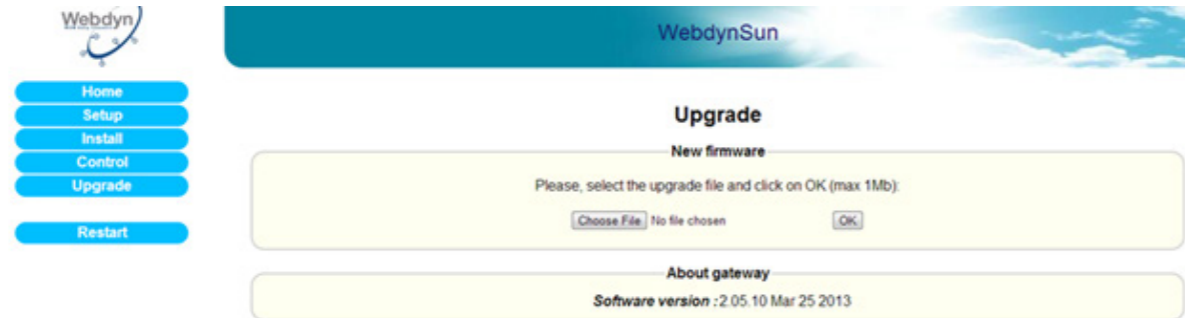

- Click on Choose file and select the “.pak” file provided by Webdyn.
- Click on OK.
- The following message is displayed.

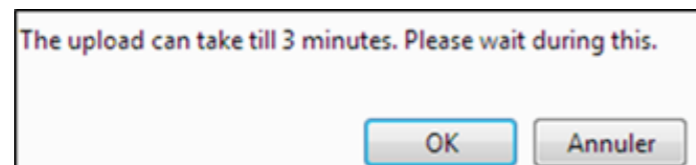

- Click on “OK” and wait until the file download onto the gateway is complete.

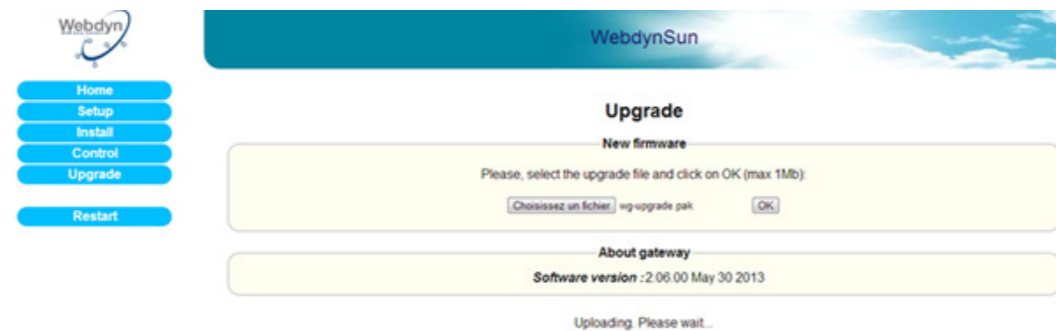

- Once the download has finished, the following page is displayed:

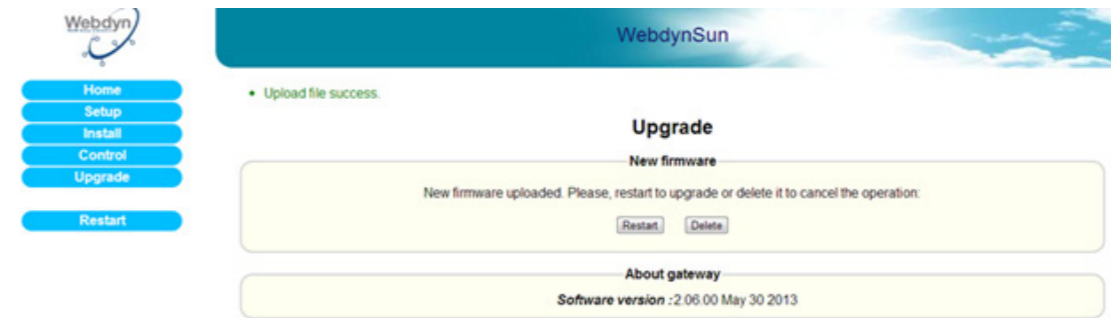

- Click on “Restart”.
- The gateway should restart. After a few seconds, all the LEDs should flash, indicating that the update is in progress.
Warning: do not disconnect the unit from the power supply during this phase.
- Wait until the update has finished (10–15 minutes) and check the version number on the home page.



Your WebdynSun gateway is now up to date.

13.2 Updating Remotely via the FTP Server

Proceed as follows for remote updating:

- Upload the new firmware supplied by Webdyn onto the FTP server.
- Modify the following variables in the configuration file prefixID_config.ini for the gateway to be updated:
 - BIN_FileName= name of the new firmware (supplied by Webdyn).
 - BIN_Checksum= checksum of the new firmware (supplied by Webdyn).
 - FTP_DirBin= name of the directory containing the new firmware.

The gateway will download its new configuration file, then its new firmware, when it next connects to the FTP server.

14. Using Web Services

The WebdynSun can access the Web Services of an HTTP server in order to retrieve information or to inform the front-end application that an action has been performed on the FTP server, such as upload or download of files. These calls are optional.

14.1 Enabling and Configuring

The use of Web Services can be enabled via the variables “WebService_Enable” and “WebService_Url” in the configuration file prefixID_config.ini.

VARIABLE	DEFINITION	DEFAULT VALUE
WebService_Enable	Enable/Disable Web Services: 0=Disabled; 1=Enabled	0
WebService_Url	http address of the Web Service (up to 29 characters)	

14.2 Format of HTTP Requests

There are two types of Web Services:

- initialisation.php => called to obtain a site number, the site ID.
- confirmation.php => called to give notification that an action has been performed on the FTP server.

The POST method is used for requests to the HTTP server.

The format of requests for Web Services complies with the following syntax:

```
URL of HTTP server/name of Web Service
```

POST data: parameters of the Web Service in the format:

```
parameter1&parameter2... parameterN.
```

The URL is configured via the variable “WebService_Url” in the configuration file.

The name of the Web Service can be “initialisation.php” or “confirmation.php”.

The possible parameters are:

```
MAC-ADR="MAC address of the gateway" in the format 00:05:F3:XX:XX:XX
NSITE="site number of the gateway"
ACTION="action performed"
ACTION-COMP="supplementary information about the action described by ACTION"
RC="return code"
RC-COMP="supplementary information in ASCII about the return code"
```

The list of Web Services and the available actions is described below:

Web Service “initialisation.php”:

NAME	POST DATA	DESCRIPTION
initialisation.php	MAC-ADR=MAC address	Automatic attribution of the site number MAC address format: XX:XX:XX:XX:XX:XX

HTTP response:

```
ReturnCode##IDsite##
```

The return codes of the responses from the HTTP server may be:

```
00: OK
13: MAC-ADR absent
-1: Internal server problem
```

Web Service “confirm.php”:

NAME	POST DATA	DESCRIPTION
confirm.php	NSITE=IDsite& ACTION=UPLOADDATA& RC=0& RC-COMP=	Informs the HTTP server that an inverter, meter, Modbus or input/output data file has been uploaded to the FTP server.

confirm.php	NSITE=IDsite& ACTION=UPLOADALARM& RC=0& RC-COMP=	Informs the HTTP server that an alarms file has been uploaded to the FTP server.
confirm.php	NSITE=IDsite& ACTION=UPLOADGLOBAL& ACTION-COMP=list of files involved& RC=0& RC-COMP=	Informs the HTTP server that configuration files have been uploaded to the FTP server.
confirm.php	NSITE=IDsite& ACTION=CONFIGGLOBAL& ACTION-COMP= list of files involved& RC=0& RC-COMP=	Informs the HTTP server that configuration files have been downloaded from the FTP server.
confirm.php	NSITE=IDsite& ACTION=UPLOADDEF& ACTION-COMP= list of files involved& RC=0& RC-COMP=	Informs the HTTP server that inverter, meter, Modbus or input/output definition files have been uploaded to the FTP server.
confirm.php	NSITE=IDsite& ACTION=CONFIGDEF& ACTION-COMP= list of files involved& RC=0& RC-COMP=	Informs the HTTP server that inverter, meter, Modbus or input/output definition files have been downloaded from the FTP server.
confirm.php	NSITE=IDsite& ACTION=CONFIGINV& RC=0& RC-COMP=	Informs the HTTP server that the file INV.ini has been uploaded to the FTP server.
confirm.php	NSITE=IDsite& ACTION=CMD& RC=0& RC-COMP=	Informs the HTTP server that a CMD file has been downloaded from the FTP server.
confirm.php	NSITE=IDsite& ACTION=CONFIGBIN& RC=0& RC-COMP=	Informs the HTTP server that a firmware file has been downloaded from the FTP server.

confirm.php	NSITE=IDsite& ACTION=VERSION& ACTION-COMP=2.03.01 Aug 1 2011& RC=0& RC-COMP=	Informs the HTTP server of the current version of the gateway firmware. This Web Service is sent on the first connection following a gateway restart.
-------------	--	---

HTTP response:

ReturnCode

The return codes of the responses from the HTTP server may be:

```
00: OK
10: Site unknown
11: Action code unknown
12: RC received unknown
13: MAC-ADR absent
-1: Internal server problem
```

14.3 Examples of Web Services Requests

Upload of a data file:

```
URL/confirm.php;NSITE=IDsite&ACTION=UPLOADDATA&RC=0&RC-COMP=
```

Download of the configuration files IDsite_config.ini and IDsite_var.ini:

```
URL/confirm.php;NSITE=IDsite&ACTION=CONFIGGLOBAL&ACTION-COMP=IDsite_
config.ini;IDsite_var.ini;&RC=0&RC-COMP=
```

Download of a new firmware release:

```
URL/confirm.php;NSITE=IDsite&ACTION=CONFIGBIN&RC=0&RC-COMP=
```

15. Tools and Diagnostics

15.1 Events Journal

On every connection, the gateway uploads a journal of events to the /LOG directory of the remote FTP server. This indicates the actions it has performed since the previous connection. It is compressed into GZ format GZ and bears the name prefixID_YYMMDD_hhmmss.log.gz.

List of messages that can appear in the events journal:

MESSAGE	DESCRIPTION
Error config file [filename] on variable [variable name]	Error in a variable in a configuration file.
FTP connection failed	Error connecting to the FTP server
GPRS signal: [RSSI]	Level of the GSM signal (1 to 31).
Firmware version: [version]	Current version of the firmware.
Restart Gateway	The gateway was restarted.

WAN connection opened	Beginning of the WAN connection.
WAN connection terminated	End of the WAN connection.

FTP get command file OK: [filename]	Command file downloaded OK.
FTP delete command file failed: [filename]	Deletion of command file failed.
FTP send ack command file failed: [filename]	Command acknowledgement file upload failed.
FTP get command file failed: [filename]	Command file download failed.

FTP send config file OK: [filename]	Upload of configuration file [filename] successful.
FTP send config file failed: [filename]	Upload of configuration file [filename] unsuccessful.

FTP get config file OK: [filename]	Download of configuration file [filename] successful.
FTP get config file failed: [filename]	Download of configuration file [filename] failed.

FTP send definition file OK: [filename]	Upload of definition file [filename] successful.
FTP send definition file failed: [filename]	Upload of definition file [filename] unsuccessful.
FTP get definition file OK: [filename]	Download of definition file [filename] successful.
FTP get definition file failed: [filename]	Download of definition file [filename] unsuccessful.

FTP get firmware OK	Firmware successfully downloaded from FTP server.
FTP get firmware failed	Firmware not downloaded from FTP server.

FTP send alarm file OK: [filename]	Upload of alarm file [filename] successful.
FTP send alarm file failed: [filename]	Upload of alarm file [filename] unsuccessful.

FTP send data file OK: [filename]	Upload of data file (Inverters, TIC, IO, MODBUS, etc.) named [filename] successful.
FTP send data file failed: [filename]	Upload of data file (Inverters, TIC, IO, MODBUS, etc.) named [filename] unsuccessful.

FTP send log file OK: [filename]	Upload of events journal [filename] successful.
FTP send log file failed: [filename]	Upload of events journal [filename] unsuccessful.
FTP send debug file OK: [filename]	Upload of debug trace file [filename] successful.

FTP send debug file failed: [filename]	Upload of debug trace file [filename] unsuccessful.
--	---

FTP send parameters file OK: [filename]	Upload of parameter file [filename] successful.
---	---

FTP send parameters file failed: [filename]	Upload of parameter file [filename] unsuccessful.
---	---

NTP synchronization OK	Synchronisation of gateway time via Network Time Protocol successful.
------------------------	---

NTP synchronization failed	Synchronisation of gateway time via NTP failed.
----------------------------	---

SMS received:Request reboot	A restart command was received via SMS.
-----------------------------	---

SMS received:Request factory	A factory reset command was received via SMS.
------------------------------	---

SMS received:Request connection	A connection request was received via SMS.
---------------------------------	--

SMS received:Request Version	A firmware version request was received via SMS.
------------------------------	--

SMS received:Change FTP parameters Server: [server] Login: [login] Password:[password]	A request to change FTP parameters was received via SMS.
--	--

SMS received:Change GPRS number [number]	A request to change the GPRS call number was received via SMS.
--	--

SMS received:Change GPRS APN [apn]	A request to change the APN was received via SMS.
------------------------------------	---

SMS received:Change GPRS login [login]	An SMS to change the APN login was received.
--	--

SMS received:Change GPRS password [password]	An SMS to change the APN password was received.
--	---

Example:

```
<0>Apr 04 13:27:10 Application: FTP send debug file OK: /LOG/
prefixID_130404_132611_debug.log.gz
<0>Apr 04 14:26:16 Application: Firmware version: 2.05.10 Mar 25 2013
<0>Apr 04 14:26:16 Application: WAN connection opened
<0>Apr 04 14:26:17 Application: NTP synchronization OK
<0>Apr 04 14:26:17 Application: FTP send data file OK: /DATA/INV/
prefixID_INV_1_1_130404_142614.csv.gz
<0>Apr 04 14:26:17 Application: FTP send data file OK: /DATA/TIC/
prefixID_TIC_130404_142614.csv.gz
<0>Apr 04 14:26:18 Application: FTP send data file OK: /DATA/IO/
prefixID_IO_130404_142614.csv.gz
```

15.2 Modem Information

It is advisable to examine the information from the modem to check that it is operating correctly.

This is done by going to the page “Control/Modem” of the built-in Web server.

The following page is displayed:



- Modem type: GPRS.
- Modem ID: IMEI number of the modem.
- SIM ID: ICCID number of the SIM card.
- SIM status: Status of the SIM card. The message may be:
 - READY: The SIM card has been inserted and the PIN code is correct. The gateway is ready to open a GPRS connection.
 - SIM PIN: The SIM card is waiting for a PIN code.
 - SIM PUK: The SIM card is waiting for a PUK code (after three unsuccessful attempts to

enter a PIN code).

- SIM ERROR: No SIM card has been inserted.
- Signal level: Quality of the GSM signal; range 1 to 31.



For an operational GPRS connection, this level must be at least 10.

- Modem status: The message may be:
 - Standby: modem not connected.
 - Initialisation: modem establishing a connection.
 - Connected: modem connected.

15.3 Detecting Power Connection

The WebdynSun constantly monitors the status of its 24 V power supply. This enables it to detect a prolonged power cut, and so warn the operator by uploading an alarm file to the FTP server. An alarm indicating that power has been restored is also uploaded.

15.3.1 Syntax of the Alarm File Name:

The name of the alarm file uploaded to the FTP server complies with the following format:

```
prefixID_AL_YYMMDD_hhmmss.csv.gz
```

Where:

prefixID: gateway identifier.

YYMMDD_hhmmss: timestamp for the archive in the format “year-month-day-hour-minute-second”.

15.3.2 Format of Alarms

The uploaded CSV alarm file may contain several alarms from different sources. The entry for a 24 V power loss alarm has the following format:

```
date-time;GATEWAY;info
```

Where:

```
date-time_N: timestamp when the alarm was triggered, in format YY/MM/DD-hh:mm:ss
```

```
info: Power OFF to indicate loss of the 24 V supply
```

```
Power ON to indicate loss of the 24 V supply
```

Example:

```
09/10/09-09:09:36;GATEWAY;Power OFF
```

15.4 LED Indicators



LED	FUNCTION	STATUS	EXPLANATION
ACTIVITY	Operational status of the gateway	On continuously (hardware version V2)	Power on
		Flashing rapidly	Initialisation
		Flashing slowly	Operational
SERVICES	Installation	Flashing rapidly	Installation phase in progress
RS485 (A)	RS485 (A) activity LED (inverters)	Flashing rapidly	Initialisation
		On continuously	Initialisation complete
		Flickering	Traffic to and from inverters

TIC	Activity on Remote Customer. Information (smart meter) interfaces	Flashing rapidly	TIC initialisation
		On continuously	Initialisation complete
		Flickering	Traffic to and from smart meters
RS485/RS232 (B)	RS485/RS232 (B) activity LED (Modbus devices)	Flashing rapidly	Modbus initialisation
		On continuously	Initialisation complete
		Flickering	Traffic to and from Modbus devices

WAN	WAN connection via Ethernet	Flashing rapidly	Ethernet connection being initialised
		On continuously	Initialisation complete
		Flashing slowly	Connection with remote server in progress
	WAN connection via GPRS	Flashing rapidly	GPRS modem being initialised
		Flashes periodically 1 to 5 times	Initialisation complete. Signal strength (number of flashes)
		Flashing slowly	Connection with remote server in progress
Connection WAN (PSTN)		Flashing rapidly	PSTN modem being initialised
		On continuously	Initialisation complete
		Flashing slowly	Connection with remote server in progress

Ethernet socket:

LED	FUNCTION	STATUS	EXPLANATION
Green LED: speed	Connection speed	Off	10 Mbps
		On	100 Mbps
Orange LED: link activity	Connection	Off	No connection
		On	Connection made
		Flickering	Data being sent or received

15.5 Installation Button

The INSTALL button, fitted on the front panel of the unit, enables forced connection or restart of the gateway as explained in the table:

ACTION	CONSEQUENCE
Press the INSTALL button for about 1 second until the SERVICE LED flashes	Besides the actions defined in §10.3.3 Connection, the gateway uploads the inverter parameter file.
Press the INSTALL button for about 10 seconds until all the LEDs on the gateway go out	The gateway restarts (the LEDs light up again about 1 minute after the restart begins)

15.6 Diagnostic SMSs

Besides the configuration SMSs described in previous chapters, some SMSs can enable initial diagnosis of a problem with the WebdynSun:

SMS	DESCRIPTION
connect	Requests a connection to the remote server
version (*)	Requests the current software version of the unit
reboot	Initiates a restart of the product

status (*)	<p>Requests information on the current configuration of the unit:</p> <ul style="list-style-type: none"> • Unit type: WebdynSun • Unit identifier (prefixID) • Software version • Connection mode (GPRS or LAN) • Information on the APN configured • SIM card identifier • GSM signal strength (RSSI) • Information on the Ethernet interface (IP, router, DNS, etc.) • Information on the remote FTP server
diag (*)	<p>Requests diagnostics on the unit interfaces:</p> <ul style="list-style-type: none"> • WAN: status of the WAN connection (OK or ERR) • FTP: status of the connection to the FTP server (OK or ERR) • NTP: NTP synchronisation status (OK or ERR) • WS: status of Web Services (OK or ERR) • TIC: status of the TIC meter link (OK or ERR) • INV: status of the inverter link (OK or ERR) • MODBUS: status of the Modbus link (OK or ERR) • DI: status of the bang-bang inputs configured • AI: status of the analogue inputs configured • DO: status of the outputs configured • DX: status of the index inputs configured
factory	Initiates a factory reset of the unit

(*) Operational only if the option to send SMSs is enabled.

15.7 Debug Traces

Occasionally, it is necessary to enable debug traces, so as to be able to diagnose a problem.

This is done by providing values for the parameters listed below, in the configuration file prefixID_config.ini:

VARIABLE	DEFINITION	DEFAULT VALUE
Log_Enable	<p>Enable/Disable debugging logs: 0=Disabled; 1=Enabled</p> <p>Reserved for use by Webdyn in support mode</p>	0
Log_Level	<p>Level of detail in debugging logs:</p> <p>0 Emerg (emergency) 1 Alert 2 Crit (critical) 3 Err (error) 4 Warning 5 Notice (default value) 6 Info (informational) 7 Debug</p> <p>Reserved for use by Webdyn in support mode</p>	5
Log_RemoteIpAddr	Syslog destination address. Reserved for use by Webdyn in support mode (up to 15 characters)	empty
Log_Port	Syslog destination port. Reserved for use by Webdyn in support mode	2000
CFG_Debug	Enable/disable configuration traces: 0=Disabled; 1=Enabled	0
INV_Debug	Enable/disable inverter traces. 0=Disabled; 1=Enabled; 2=Verbose mode	0
MODBUS_Debug	Enable/disable Modbus device traces. 0=Disabled; 1=Enabled; 2=Verbose mode	0
TIC_Debug	0=Disabled; 1=Enabled	0
IO_Debug	Enable/disable input/output traces	0



Enabling debug traces is likely to generate much greater GPRS traffic.

The traces are subsequently sent out via UDP and on every connection, stored in the directory /LOG of the remote FTP server in the form of a compressed file named prefixID_YYMMDD_hhmmss_debug.log.gz.

15.8 Factory Reset Procedure

A mechanism to reset the gateway to its factory default parameter settings is provided to deal with problems of access to the WebdynSun.

To carry out this factory reset, please proceed as shown below:

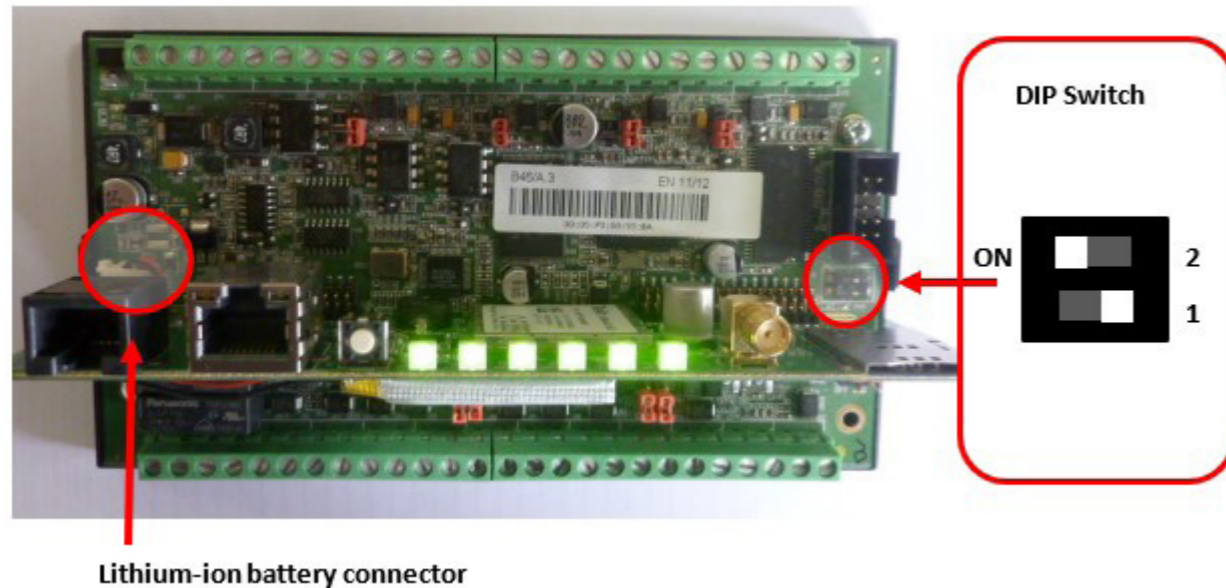

- Turn off the power supply to the unit.
- Open the casing of the WebdynSun to gain access to the configuration DIP switch.
- Disconnect the lithium-ion battery.
- Set DIP switch 2 to ON.
- Turn on the power supply to the unit.
- Wait for the unit to restart automatically, after all the LEDs flash simultaneously (around 2 minutes).
- Reset DIP switch 2 to OFF.
- Reconnect the lithium-ion battery.
- Close the unit.



A factory reset does not delete the collected data.

Sales Contact

SPAIN

C/ Alejandro Sánchez 109
28019 Madrid

Phone 1: 902.19.81.46
Phone 2: +34-91.560.27.37
Email: contact@webdyn.com

FRANCE

26 Rue des Gaudines
78100 Saint-Germain-en-Laye

Phone: +33.139042940
Email: contact@webdyn.com

INDIA

803-804 8th floor, Vishwadeep Building
District Centre, Janakpurt, 110058 New Delhi

Phone: +91.1141519011
Email: purchase-india@webdyn.com

PORTUGAL

LusoMatrix Lda.
Av. Coronel Eduardo Galhardo 7-1°C
1170-105 Lisbon, Portugal

Phone: +351.218162625
Email: comercial@lusomatrix.pt

APAC

9F, No. 156, Sec. 3, Minsheng E. Rd.
Songshan Dist., Taipei City 10596, Taiwan

Phone: +886.965333367
Email: ahsu@matrix.es

AUE

Dubai

Phone: +34.915602737
Email: hperchin@matrix.es

USA

Chicago

Phone: +34.915602737
Email: jcabezas@matrix.es